



ROCHESTER
PUBLIC UTILITIES
WE PLEDGE, WE DELIVER™

2024

**ELECTRIC
SERVICE
RULES**

ROCHESTER PUBLIC UTILITIES

ELECTRIC SERVICE RULES AND REGULATIONS

Revised: **February 2024**

INTRODUCTION

Rochester Public Utilities (hereafter referred to RPU) has assembled this booklet to assist its customers and their architects, engineers, or electrical contractors to plan for and obtain electric service. The requirements herein supersede all previous publications of the “Electric Service Rules and Regulations” issued by RPU prior to the above date and is subject to change without notice.

The information presented here is intended to supplement the requirements of the National Electrical Code® (NEC®), National Electric Safety Code® (NESC®), National Fuel and Gas Code (NFPA54), Liquefied Petroleum Gas Code (NFPA58), and all other applicable federal, or state, and municipal codes, regulations, laws and ordinances. It is always necessary to refer to and comply with such other codes, regulations, laws, and ordinances when planning, designing, and installing a new electrical service. Specific requirements of RPU do not intentionally conflict with any other requirements known to be in effect as of the publication date of this booklet. Any apparent conflicts of this nature should be brought to the attention of RPU for interpretation. RPU assumes no responsibility whatsoever for the manufacturer’s, supplier’s, electrician’s, or engineering consultant’s compliance with all applicable codes as well as all local and state codes. Any waiver at any time of RPU’s rights or privileges under the electric service rules and regulations will not be deemed a waiver as to any breach of other matter subsequently occurring.

All questions or requests should be directed to RPU’s Customer Care Department at the contact number or email address listed on page 2.

These electric rules and regulations are available for download from RPU’s website <https://www.rpu.org/construction-center.php>. Contact RPU for more details.

RPU ELECTRIC CONTACT INFORMATION

Main Office Address: 4000 East River Rd NE
Rochester, MN 55906-2813

Web Address: <https://www.rpu.org>

Contact	Phone Number	Email
Customer Care	507.280.1500	customerservice@rpu.org
Customer Care: Toll Free	800.778.3421	
Emergency Electrical Outages (24 hours)	507.280.9191	
Electric Engineering Department	507.292.1216	EDistribution@rpu.org
Metering Department	507.292.1232	
Modified or New Service	507.292.1232	newservice@rpu.org

OTHER CONTACT INFORMATION

Contact	Phone Number	Website
GOPHER STATE ONECALL	800.252.1166	www.gopherstateonecall.org
Rochester Building and Safety Department	507.328.2600	

REVISION HISTORY

<i>Revision Date</i>	<i>Brief Description of Revisions</i>
Aug 2011	Starting Revision for tracking
May 2015	Major Revisions
August 2017	Revisions
July 2021	Revisions
February 2024	Revisions

TABLE OF CONTENTS

INTRODUCTION	1
RPU ELECTRIC CONTACT INFORMATION	2
REVISION HISTORY	3
TABLE OF CONTENTS	4
SECTION 100 – DEFINITIONS	7
SECTION 200 – GENERAL INFORMATION	13
201 SERVICE JURISDICTION.....	13
202 APPLICATION FOR SERVICE	13
203 OWNERSHIP OF EQUIPMENT	14
204 EASEMENTS	15
205 INSPECTION OF CUSTOMER’S FACILITIES.....	15
206 SERVICE CONNECTION, DISCONNECTION & RECONNECTION	17
207 LIABILITY	18
208 SERVICE INTERRUPTIONS	18
209 ACCESS.....	18
210 CUSTOMER RESPONSIBILITY	18
211 REVISIONS OF REQUIREMENTS	19
SECTION 300 – STANDARD SERVICES	20
301 GENERAL CHARACTERISTICS	20
302 AVAILABILITY OF SERVICE	20
303 SECONDARY SERVICE VOLTAGE	20
304 PRIMARY SERVICE VOLTAGES	21
SECTION 400 – SPECIAL SERVICES	22
401 TEMPORARY SERVICE REQUIREMENTS	22
402 SERVICES FOR UNUSUAL LOAD CHARACTERISTICS	23
403 EXCESS FACILITIES.....	23
404 REDUNDANT FACILITIES.....	23
405 RELOCATION OR PROTECTION OF RPU FACILITIES.....	24
406 REWIRING OR UPGRADING EXISTING FACILITIES	24
SECTION 500 – DISTRIBUTED ENERGY RESOURCES	25
501 GENERAL INTERCONNECTION REQUIREMENTS.....	25
502 TECHNICAL REQUIREMENTS	25
SECTION 600 – METERS AND METERING EQUIPMENT	26
600 GENERAL	26
601 METERING EQUIPMENT RESPONSIBILITIES	26
602 LOCATION OF METERS	26
603 GROUPED METERS	29
604 METER IDENTIFICATION	29
605 OUTDOOR METER MOUNTING	30
606 INDOOR METER MOUNTING	30
607 METER CONNECTIONS	30
608 WIRING RESTRICTIONS ON METER/METER SETS.....	31
609 METER TESTING	31
610 METER SEALS & LOCKS.....	32
611 INSTRUMENT TRANSFORMER METER INSTALLATIONS	32

612	SELF-CONTAINED METER INSTALLATIONS	34
613	MASTER METERING INSTALLATIONS	35
614	APPROVED METER SOCKETS	35
615	SERVICE AT 480 VOLTS	36
616	LOCATION OF HIGH-LEG IN METER SOCKET ON 240/120 VOLT, 3-PHASE SERVICES	36
617	REMOVING RPU SEALS, LOCKS AND METERS	37
618	CUSTOMER GENERATION	37
619	PROPER GROUNDING/BONDING OF METER SOCKETS & SERVICES	37
620	CUSTOMER DISCONNECT SWITCH	37
621	SPECIAL SOCKETS	38
622	RPU OWNED EQUIPMENT	38
623	TEMPORARY REMOVAL OF CUSTOMER OWNED METER SOCKETS	38
624	PULSE INITIATING DEVICE	38
SECTION 700	– CUSTOMER UTILIZATION EQUIPMENT	40
701	PROTECTION OF CUSTOMER EQUIPMENT	40
702	MOTOR STARTING CURRENTS	41
703	POWER FACTOR	41
704	FAULT CURRENTS	42
705	WIRING ADEQUACY	42
706	CUSTOMER-OWNED GENERATING EQUIPMENT	42
707	CUSTOMER'S OBLIGATIONS	42
SECTION 800	– OVERHEAD SECONDARY SERVICES	44
801	SCOPE	44
802	TRANSFORMER LIMITATIONS	44
803	SERVICE DROP CONDUCTORS	45
804	REQUIRED CLEARANCES	45
805	SERVICE ATTACHMENT PROVISIONS	45
806	OVERHEAD SERVICE MAST REQUIREMENTS	46
SECTION 900	– UNDERGROUND SERVICES	48
901	NEW RESIDENTIAL DEVELOPMENTS	48
902	RESIDENTIAL UNDERGROUNDING IN OVERHEAD AREAS	48
903	UNDERGROUND SERVICE TO COMMERCIAL & INDUSTRIAL CUSTOMERS	48
904	SECONDARY CONNECTION CABINETS	50
905	TRANSFORMER CLEARANCES	51
906	OTHER PAD-MOUNTED EQUIPMENT CLEARANCES	51
907	WINTER INSTALLATION	51
908	INSTALLATION IN UNSUITABLE SOILS	51
909	TOTAL UNDERGROUNDING	51
SECTION 1000	– TRANSFORMERS AND TRANSFORMER DATA	52
1001	TRANSFORMERS	52
1002	GROUNDING	52
1003	SPECIAL RULES	52
1004	FAULT CURRENT	53
1005	ARC FLASH	53

SECTION 1100 – SUPPLEMENTAL INFORMATION	58
1101 USE OF SERVICE	58
1102 RATE SCHEDULE CLASSIFICATION	62
1103 PAYMENT	62
1104 CUSTOMER CHARGE.....	62
1105 NEW UNDERGROUND RESIDENTIAL SERVICE CONNECTION CHARGE.....	63
1106 SERVICE DISCONNECTION/RECONNECTION.....	63
1107 SERVICE DEPOSIT	64
1108 POWER FACTOR CORRECTION CALCULATION	64
SECTION 1200 – EXHIBIT DRAWINGS & INFORMATION	67

SECTION 100 – DEFINITIONS

Altered: Replacing major components or any integral part of a meter socket, current transformer cabinet, riser, service mast, line or load side conductor, or relocating electric service equipment (including storm damage).

Application for Service: The agreement or contract between RPU and the customer under which electric service is supplied and taken.

Accessible: Allowing or admitting, close approach; not guarded by locked doors, elevation, or other effective means including any portion of a temporary or permanent structure.

Approved: Acceptable to the authority having jurisdiction.

Building: A structure with roof and walls. Two (2) or more structures shall not be considered a single building merely by the existence of skyways, tunnels, common heating or cooling facilities, common garages, entry halls or elevators, or other attachments.

Cold Sequence: In a cold meter sequence, a disconnecting device is located on the line side (before) of the metering equipment.

Conduit: Standard tubular material used for mechanical protection of electrical distribution lines which may be exposed, buried beneath the surface of the ground, or encased in a building as required. (See definition for Duct).

NOTE: For the purpose of this document, the terms Conduit and Duct are used interchangeably

Connected Load: The combined manufacturer's rated capacity of all motors and other electric energy consuming devices on the customer's premises which may, at the will of the customer, be operated with the electric energy to be supplied from the service of RPU.

Contractor: Licensed individual or company who performs work on behalf of the customer or RPU.

Current Transformer (CT): An instrument transformer designed for the measurement or control of current.

Customer: Any individual, partnership, corporation, or other legal entity now being served or to be served, using the electric service of RPU at any specified location.

Customer's Service Equipment: The necessary equipment and accessories, located near the point of entrance of supply conductors to a building, which constitute the main control and means of disconnecting the supply to that building. This equipment usually consists of a circuit breaker or a switch and fuses.

Disconnection Means: A device, or group of devices, or other means by which the conductors of a circuit can be disconnected from their source of supply.

Distribution Lines: RPU's lines located along streets, alleys, highways, or easements on private property, when used or intended for use for general distribution of electric service to customers.

Distributed Energy Resource (DER): Often referred to in the past as Distributed Generation (DG) and on occasion also interchanged with the term Qualifying Facility (QF). DER are all types of generation and energy resources that can be interconnected to RPU's electric distribution system. DER technologies can include photovoltaic solar systems, wind turbines, storage batteries, or fossil fuel generators are not limited to renewable types of technologies.

Distributed Generation (DG): Distributed Energy Resources that are derived from a generation source, not from energy storage.

Duct: Standard tubular material used for mechanical protection of electrical distribution lines which may be exposed, buried beneath the surface of the ground, or encased in a building as required. (See definition for Conduit).

NOTE: For the purpose of this document, the terms Conduit and Duct are used interchangeably

Dwelling Unit: A structure or the part of a structure that is used as a home, residence, or sleeping place by one person who maintains a household or by two or more persons who maintain a common household. The term "Dwelling Unit" excludes real property used to accommodate a manufactured home, unless the manufactured home is rented or leased by the landlord

Easement: The right of use over and under the property of another, such as a right-of-way.

Electric Service: The availability of electric power and energy, regardless of whether any electric power and energy is actually used. The supplying of electric service by RPU consists of the maintaining, at the point of delivery, approximately the agreed voltage, phase and frequency by means of facilities adequate for carrying the load which RPU is thereby obligated to supply by reason of the known requirements.

Excess Facilities: Those instances where RPU provides distribution and/or metering facilities at the customer's request, in excess of the facilities RPU deems necessary to supply service to the customer.

Fault Current: The current that will flow through the system to a point where a piece or a conductor has failed, such as bare conductors touching together or a bare conductor touching a ground point.

Frost (Frozen Ground): A condition where the water contained within the ground freezes, resulting in additional difficulty and expense in excavation work.

Hot Sequence: In a hot meter sequence, there is not a disconnecting device located on the line side (before) the meter.

Individual RPU Metering: Direct measurement by RPU, using a RPU meter, of all electrical consumption of a customer supplied by the company.

Instrument Transformer: A transformer that reproduces in its secondary circuit, the voltage or current proportional to its primary circuit.

Instrument Transformer Cabinet: A cabinet installed and owned by the customer, complying with RPU's requirements, and designed for housing instrument transformers used for metering.

Junction Cabinet: A pad-mounted enclosure where underground primary cables are connected together, either by splices or separable connectors, for underground distribution systems.

Manufactured Home: A structure, not affixed to or part of a real estate, transportable in one of more sections, which in the traveling mode, is eight body feet or more in width or 40 body feet or more in length, or when erected on site, is 320 or more square feet, and which is built on a permanent chassis and designed to be used as a dwelling unit.

Master Metering: Metering configuration where a single meter (Master meter) measures the consumption for a building, and then sub-meters on the Customer side of the Master Meter measure the consumption of individual load, loads, or groups of loads.

Meter/Meter Set: The equipment necessary to measure the customer's electric energy usage and demand, including a meter socket, instrument cabinet, instrument transformers, protective device, conduit, associated wiring and meter

Multi-Family Dwelling: A building containing two or more dwelling units

National Electrical Code® (NEC®)¹: The current edition of the National Electrical Code as issued by the National Fire Protection Association (NFPA No. 70).

National Electric Safety Code® (NESC®)²: The current edition of the National Electric Safety Code as issued by the Institute of Electrical and Electronics Engineers (IEEE® C2), American National Standards Institute (ANSI® C2).

¹ National Electrical Code® and NEC® are registered trademarks of the National Fire Protection Association, Inc., Quincy, MA 02269

² National Electric Safety Code® and NESC® are registered trademarks and service marks of the Institute of Electrical and Electronics Engineers, Inc. New York, NY 10017

Nominal Voltage: The value, expressed in volts, which is assigned to a circuit or system for the purpose of conveniently designating its voltage class (such as 120/240V, 277/480Y, etc.). The actual voltage at which a circuit operates can vary from the nominal within a range established by ANSI C84.1. The customer is responsible for **ensuring** that their systems are capable of operating within range B of ANSI C84.1

Occupancy Unit: A room, office, apartment, or other space separated by walls or partitions that enclose the area, or a contiguous grouping thereof when occupied by a single customer.

Paved: A surface covered with a material such as stone, asphalt, or concrete designed for vehicular traffic.

Point of Delivery: The point where the electric energy first leaves the line or apparatus owned by RPU and enters the line or apparatus owned by the customer. This is not necessarily the point of location of RPU's meter.

Point of Interconnection: The location designated by RPU that the Customer must extend conduits to in order for RPU to install our facilities on customer property.

Primary Service: Any type of service with a nominal voltage greater than 600 volts.

RPU: Rochester Public Utilities

Rate Schedules: The classification of the use of electricity into categories considering the amount of power supplied and the purpose of its use.

Redistribution: The provision of unmetered electrical supply by a customer to customer's tenants or other occupant, or to any person who qualifies for unmetered service.

Redundant Facilities: Duplicate (partial or full) facilities installed at the request of the customer for the purpose of increasing reliability of the system for a particular customer.

Single Family Dwelling: A building consisting solely of one dwelling unit.

Secondary Connection Cabinet: Cabinet required when the number and/or size of the conductors exceeds RPU's limit for terminating in a specific pad-mounted transformer. If a secondary connection cabinet is used, it will also be the location of the metering equipment.

Secondary Service: Any type of service with a nominal voltage less than or equal to 600 volts.

Secondary Terminal: The secondary side of a pad-mounted transformer, service pedestal, or vault, whichever is designated by RPU.

Series Subtractive Metering: An arrangement to measure consumption in a multiple occupancy unit building using individual RPU meters on each occupancy unit in series with one RPU master meter to measure total building consumption on the set of service entrance conductors or feeder supplying the individual occupancy units with billing for common area usage determined by company formula.

Service: The conductors and equipment for delivering energy from RPU's system to the wiring system of the customer.

Service Drop: The overhead service conductors from the last pole or other aerial support up to, and including the splices (if any), connecting to the service-entrance conductors at the building or other structure.

Service Entrance Conductors, Overhead System: The service conductors between the terminals of the service equipment and a point usually outside the building, clear of building walls, where joined by tap or splice to the service drop.

Service Entrance Conductors, Underground System: The service conductors between the terminals of the service equipment and the point of delivery.

Service Equipment: The necessary equipment, usually consisting of a circuit breaker or switch and fuses, and their accessories, located near the point of entrance of supply conductors to a building or other structure, or an otherwise defined area, and intended to constitute the main control and means of cutoff of the supply.

Service Upgrade: An electric service is considered upgraded if any of the following conditions are met:

1. If the rating of the customer disconnect is increased
2. If the main service disconnect type is changed (i.e. from fuses to a circuit breaker)
3. If either the conductors between the meter socket and the customer disconnect or the conductors on the supply side of the meter are changed **or altered**
4. A DER system is installed by the customer
5. **A home emergency generator with an automatic transfer switch (ATS) is installed by the customer**

Sub-metering: The provision of metered electrical supply through a customer owned meter to a customer's tenants, cooperative or condominium owners, other occupants, or to a portion of the customer's own electrical consumption.

Underground Residential Distribution (URD) Areas: Those residential subdivisions, or other specified areas, within which all customers are served by underground distribution lines.

Underground Service Lateral: The secondary service conductors from RPU's distribution system.

Unsuitable Backfill Material: Includes, but is not limited to, the following materials:

- Granular material (individual stones, soil in clumps or clods, etc.) larger than 1/4" in diameter
- Frozen materials
- Materials removed as rock excavation or over-excavation
- Trash, metal, or construction waste
- Environmentally contaminated soils

Utility: For the purpose of this document any public, city, or city-franchised organization that furnishes electric service.

Voltage to Ground: For grounded circuits, the voltage between the given conductor and that point or conductor of the circuit that is grounded; for underground circuits, the greatest voltage between the given conductor and any other conductor of the circuit.

Voltage Transformer (VT): An instrument transformer intended for use in the measurement or control of a circuit and designed to have its primary winding connected in parallel with the circuit.

SECTION 200 – GENERAL INFORMATION

201 SERVICE JURISDICTION

RPU has been established by the City of Rochester for the purpose of providing electricity to the residents of the City. RPU also provides electricity to residents outside of the City limits but within the service area boundaries established by the State of Minnesota. Service will be provided to all eligible applicants only when all applications, agreements, easements, deposits, payments, and other required information have been provided to RPU.

202 APPLICATION FOR SERVICE

Application for initial, additional, or temporary electric service must be made by the customer, or a designated representative, to RPU. Applications can be made at RPU's Service Center or by contacting a Modified or New Service Representative (refer to page 2 for contact information). At the time of application, the customer will be required to provide, in writing on the form(s) provided, information relating to the service request, including the following:

- (1) Exact location of premises to be served, including building street address, apartment or unit number if applicable, lot and block numbers, and name of subdivision
- (2) The type of service desired (e.g. temporary, permanent, residential subdivision, dwelling unit, commercial, industrial, rewire, etc.)
- (3) The approximate date that electric service is required
- (4) The name, address, and telephone number of the customer's designated representative who will be responsible for working with RPU representatives in providing the electric service (e.g. customer, employee, engineer, contractor, etc.)
- (5) Commercial Services:
 - a) Load Data Sheet: The customer, or their representative, shall submit to RPU's Engineering Department a completed Electrical Load Data sheet specifying the type of service required by the customer and expected magnitudes of connected and peak load. Additional data in the form of construction drawings and the proposed service entrance may also be necessary for RPU to adequately determine the capacity and arrangement of service to the customer. The completed Load Data sheet must be received before RPU can perform the necessary planning and design of the project. Failure to provide this information at the start of a project may result in significant delay in RPU being able to provide service

- b) The Commercial Service Application must be submitted as soon as feasible in order for RPU to establish an account, and allow adequate time to invoice and receive payment for the Line Extension Fee, if applicable
 - c) Notification to RPU Engineering that the customer is ready for installation of the transformer must be received a minimum of ten (10) working days prior to energizing the service
- (6) **Residential Subdivisions:**
- a) **Complete Residential Line Extension billing information form and submit with CAD file of plat at least six (6) months in advance**

RPU should be advised of planning installations as early as possible so that details for furnishing service may be arranged and construction completed by the desired date. Application forms and additional information may be obtained at <https://www.rpu.org/construction-center.php>. Contact a RPU Modified or New Service Representative (refer to page 2 for contact information) with questions concerning the application process.

203 OWNERSHIP OF EQUIPMENT

203.1 RPU-Owned Equipment - The meter and associated metering equipment furnished or installed by RPU are the property of RPU.

- (1) Overhead Service – In addition to the metering equipment, the overhead service drop installed by RPU is the property of RPU
- (2) Underground Service – In addition to the metering equipment, all equipment up to and including the designated point of delivery is the property of RPU

203.2 Customer-Owned Equipment - The meter socket, instrument transformer compartment (if required, see Section 611), the service entrance conductors and conduit from the meter socket to the service entrance disconnect, the service entrance switch or circuit breaker, the service entrance ground equipment, and the concrete transformer pad and grounding grid are the property of the customer.

- (1) Overhead Service – In addition to the equipment on the customer side of the meter socket, the service drop wire holder or bracket, the weather head, and either the service mast and conduit with entrance wires, or the service entrance cable with watertight connection to the meter socket are the property of the customer
- (2) Underground Service – In addition to the equipment on the customer side of the meter, all conduit and cable required to extend the secondary service

lateral from RPU's point of delivery to the meter socket are the property of the customer

203.3 Responsibilities - The customer and RPU are responsible for the installation, maintenance, repair, and replacement of the electric service equipment which each owns.

204 EASEMENTS

Whenever any RPU-owned underground and/or overhead material and equipment is located above or below the customer's property, the customer shall grant an easement to RPU to the extent which RPU deems necessary. All utility easements required by RPU are to be granted by the customer at no cost to RPU.

204.1 Easement Legal Description and Exhibit Processes

- (1) Rochester Community Development – When the easement is sought during the Rochester Community Development process, the customer or property developer shall provide the legal description and exhibit by a Registered Land Surveyor
- (2) Other Easement Request – When the easement is sought after the property has been developed, RPU will provide an electronic copy of the assembled easement (legal description and exhibit by RPU staff) for the property owner's signature. Once sign-off by the property owner is received by RPU, RPU will record the signed easement paperwork

204.2 Change of Grade - The finished grade in any platted or recorded utility easement shall not be altered without first contacting RPU Engineering to determine if electric facilities are installed within the easement. Permission may be granted to change the finished grade by RPU Engineering if the proposed grade change will not affect minimum burial depth requirements for ducts or require removal and reinstallation of above grade facilities such as transformers, poles, secondary pedestals, etc. Replacement and/or relocation of RPU facilities, at customer's expense, may be required if necessitated by the proposed grade change. RPU Engineering will provide a cost estimate for all work associated with the proposed grade change for approval prior to the commencement of any proposed grade change work. Payment must be received and cleared prior to the start of any work by RPU.

205 INSPECTION OF CUSTOMER'S FACILITIES

205.1 Requirements – As a minimum, wiring and electrical equipment of the customer shall be installed in accordance with the latest edition of the National Electrical Code®.

205.2 Inside City Limits – Customer services and associated wiring installations located within the Rochester city limits, including temporary installations, must be inspected and approved by an authorized inspector of the City Building Safety Department as required by Minnesota Statutes Section 326.B.36. RPU will make connection only after approval by the authorized inspecting authority. The inspector is required by Minnesota Statutes Section 326.B.36 to disconnect or have disconnected by the utility any installation that is declared by the inspector to be unsafe and a hazard.

205.3 Outside City Limits – Customer services and associated wiring installations located outside the Rochester city limits and requesting service from RPU must have their wiring inspected by a state inspector. RPU will make connection before authorization from the state inspector only if the master electrician who installed or supervised the installation agrees in writing to be responsible for said wiring until such time that it can be inspected and approved by the state inspector (“Request for Electrical Inspection” – white form).

205.4 Disconnected Service Inspection – For any electric service that has been disconnected for more than ninety (90) days prior to a reconnection request, the customer will be required to hire a licensed electrical contractor to perform an inspection of the building or dwelling’s electrical wiring to verify that no unsafe or hazardous conditions are present. **The procedure listed below is required in order for RPU to re-energize the service:**

- (1) **Customer’s licensed electrical contractor shall contact Rochester Building Safety Electrical Inspections to inform them of the passing inspection**
- (2) **Customer or customer’s licensed electrical contractor shall be present on-site to open the main service disconnect prior to RPU personnel re-energizing the service**

Exception:

Multi-family dwellings that have 6 meters or more installed, with at least one (1) meter in the ganged service entrance energized, are exempt from the above requirement

205.5 Other Required Inspections (Forms can be found at <https://www.rpu.org/construction-center.php>)

- (1) **Transformer Pad** – Prior to pouring concrete, the customer, or customer’s contractor, shall complete and submit to RPU’s Engineering Department the completed “Request for Transformer Pad Inspection” form, with multiple photos. RPU personnel will review the photos and visually inspect the formed pad within the timeframe noted on the form. Observed deficiencies will be communicated to the contact listed on the submitted inspection form. **Corrections and re-inspection by RPU personnel must be made before approval to pour concrete will be given.** RPU reserves the right to refuse service if the transformer pad is poured prior to inspection and correction of noted deficiencies

- (2) Subdivision Installation – The customer, or customer’s contractor, shall complete and submit to RPU’s Engineering Department the completed “Developer **Notification of Subdivision Readiness for Utility Installation**” form. The site will then be inspected for compliance with requirements. If no deficiencies are found, the site will be scheduled for joint utility installation. If any deficiencies are found, corrections must be made and a new form re-submitted for inspection prior to the site being scheduled for joint utility installation

206 SERVICE CONNECTION, DISCONNECTION & RECONNECTION

206.1 Site Readiness – After the customer’s installation has been inspected and approved by the proper authority, a meter will be installed by RPU and the electric service made available provided that all applications, fees, agreements, and deposits have been submitted by the customer and approved by RPU. Inspection notices must be received by RPU two (2) business days prior to the date that the connection is desired (weekends and holidays excluded). Under special circumstances, verbal inspections will be accepted as long as written inspection documentation is submitted immediately thereafter.

206.2 Notification – Customer requests for disconnection or reconnection of existing services must be received by RPU two (2) business days prior to the desired time of disconnection or reconnection (weekends and holidays excluded). For the mutual protection of the customer and RPU, only authorized employees of RPU are permitted to set and remove meters, or to make and energize or break and de-energize the connection between RPU’s service drop or secondary terminals and the customer’s service entrance conductors or underground service laterals.

206.3 Building Demolition – If a building is scheduled for demolition, the contractor shall notify RPU’s New Services Department for a service disconnect a minimum of two (2) business days prior to the start of demolition. RPU will then issue a work order to disconnect the service. There is no RPU charge for the retirement of electric service.

If at some future time the owner at the location requires service, the owner shall be required to submit a new “APPLICATION FOR SERVICE” request, pay any and all liens or amounts encumbered by RPU and/or any outstanding RPU charges before an account will be reactivated.

206.4 Commercial Customer Requested Outage – Customer shall contact their Commercial Account Representative. Contact information can be found at <https://www.rpu.org/contact-us.php> or by calling the RPU Customer Care number listed on page 2 of this document.

207 LIABILITY

207.1 Damage as Result of Service – RPU does not engage in the practice of doing interior wiring on the customer’s premises except for the installation and maintenance of its own property, and therefore, is not responsible for service beyond the point of delivery. RPU shall not be liable for damage to any customer or to any third party resulting from the use of the service or from the presence of RPU appliances or equipment on the customer’s premises.

207.2 Responsibility – The customer is solely responsible for any accidents, fires, or failures resulting from the condition and use of **their** wiring installation or equipment.

208 SERVICE INTERRUPTIONS

208.1 Notice – RPU reserves the right to interrupt service at any time. Interruptions for maintenance and system improvements will be prearranged and advance notice will be given to the customer whenever practical.

208.2 Responsibility – RPU will not be responsible for consequential damages resulting from service interruptions or fluctuations outside its control or from operations in response to abnormal system conditions. Customers requiring service reliability and/or stability exceeding RPU’s normal service should consider uninterruptible power supplies, isolation transformers, power conditioners, redundant services, or other options to provide the level of service needed. RPU’s Engineering Department is available to discuss such needs.

209 ACCESS

Employees of RPU shall have the right of access to the customer’s premises at all reasonable times for the purpose of installing, reading, inspecting, maintaining, or removing any of its meters, devices, or other equipment which is used in connection with the furnishing of the customer’s electric service. **If a key is required to access locked locations containing RPU’s electric metering equipment, the customer will provide RPU personnel with a key to keep in our possession, or RPU will provide a key lock box for the customer key to be kept on-site at the metered location. All meter locations must have matching keys for RPU access to the metering equipment. RPU reserves the right to charge a meter service call fee if we cannot access our electric metering equipment.**

210 CUSTOMER RESPONSIBILITY

Failure of the Customer to notify RPU in a timely manner of any planned alteration to electric service facilities or increased electrical load, and failure to comply with RPU’s published rules, regulations, and rate schedules may result in delayed connections, interruption of service, or damage to equipment, for which RPU disclaims all responsibility.

211 REVISIONS OF REQUIREMENTS

All requirements stated or implied herein are subject to change at any time without prior notice.

SECTION 300 – STANDARD SERVICES

301 GENERAL CHARACTERISTICS

This section describes the types of services offered to customers under RPU's standard rate schedules. Electric service supplied by RPU is alternating current having a nominal frequency of 60 Hertz (cycles per second).

302 AVAILABILITY OF SERVICE

Although the types of service listed in subsequent sections are generally available through the area served by RPU, service of the type requested by a customer may not be available at the location where such service is desired, and in certain cases may be available only through special contractual arrangements and at the expense of the customer. Each customer will generally be allowed only one type of service and one point of delivery for each location.

302.1 Redundant Services – Refer to Section 404 for requirements.

302.2 Multiple Services – Only one (1) service installation to a customer's service equipment is allowed. During customer renovation or service upgrade work, should RPU determine that a customer's service equipment has multiple services connected to it, RPU Engineering will work with the customer to eliminate the multiple service installation as soon as possible.

303 SECONDARY SERVICE VOLTAGE

The following types of secondary service are generally available to customers served under RPU's standard rate schedules:

303.1 Single Phase Service – 120/240 Volt, 3-Wire, Grounded Neutral: Generally available where the total load is 100 kVA or less for pad-mount service, or 50 kVA or less for pole-mounted service, with an underground secondary in each case.

303.2 Three Phase Service – Generally available where facilities of adequate capacity are adjacent to the premises to be served

- (1) 208Y/120 Volt, 4-Wire, Grounded Neutral: Generally available to customers with loads determined by RPU to be 75 kVA or greater for pad-mount service, or 45 kVA **maximum** for pole-mounted service, with an underground secondary in each case. The maximum size pad-mounted transformer that RPU will install for this service voltage is 1000 kVA
- (2) 240/120 Volt, Delta, 4-Wire, Grounded Neutral: No longer available as a new standard service

- (3) 240 Volt (and 480 Volt), Delta, 3-Wire: No longer available as a new standard service
- (4) 480Y/277 Volt, 4-Wire, Grounded Neutral: Generally available to customers with loads determined by RPU to be 75 kVA or greater for pad-mount service, or 45 kVA **maximum** for pole-mounted service, with an underground secondary in each case. The maximum size pad-mounted transformer that RPU will install is 2500 kVA

303.3 New Development Cost Calculation – Refer to RPU Line Extension Policy. Any costs assessed to the project by RPU will need to be paid by the customer prior to RPU performing facility installation.

303.4 Redevelopment Cost Calculation – Contact RPU's Engineering Department for determination of cost (if any) that will be assessed to the project by RPU.

304 PRIMARY SERVICE VOLTAGES

Three-Phase, 13800Y/7970 Volt, 4-Wire, Grounded Neutral Service: Available only by special request where the total annual peak load at one site is projected by RPU to exceed 500 kW. RPU reserves the right to deny a request for a primary voltage service. Where provided, the point of delivery will normally be the terminals of RPU's cable in **either** the customer's switchgear **or in limited cases, the RPU supplied primary metering cabinet. Please contact RPU's Engineering Department for switchgear bay requirements and approval when utilizing this service option.**

SECTION 400 – SPECIAL SERVICES

401 TEMPORARY SERVICE REQUIREMENTS

401.1 General – Temporary service is intended to be supplied at secondary voltages only to customers for use during the construction of permanent facilities and before the permanent service can be installed.

401.2 Address – The address of the location to be supplied with temporary service must be permanently displayed at the location and on the temporary pedestal/meter location and be easily readable from the street before RPU will install the temporary service. All overhead and underground temporary services will be metered and billed under one of RPU's standard rate schedules.

401.3 Installation – The customer shall provide an approved meter socket with the necessary raceway and a suitable rigid support for attachment of the metering equipment and service drop. On all three phase temporary services, where required, the customer shall also provide a suitable enclosure for installation of RPU's instrument transformers.

401.4 Installation Length – Service to any electrical installation for a period of less than two (2) years shall be considered as "temporary service". Any installation that remains in service longer than this timeframe must be changed to a permanent service installation when directed by RPU.

401.5 Fees - Temporary electrical services costs shall be in accordance with the following requirements listed below:

- (1) Secondary Available at Property:
 - a) A temporary meter installation fee will be assessed for a single phase temporary service installed for construction. The location of the temporary service will be designated by RPU
- (2) RPU has primary voltage facilities available on or adjacent to the lot and setting of a transformer is required:
 - a) A temporary meter installation fee and a temporary facilities installation fee will be assessed for the temporary service installed for construction. The location of the temporary service will be designated by RPU
- (3) RPU does not have adequate facilities in the area:
 - a) The customer will be required to pay RPU for the actual cost to install and remove the temporary service(s)

- (4) Information regarding the charges for temporary service can be obtained from RPU Engineering. RPU may require temporary service fees to be paid in advance.

402 SERVICES FOR UNUSUAL LOAD CHARACTERISTICS

402.1 Customer Transients – The operation of customer equipment having a relatively high load of short or intermittent duration, such as welders, compressor motors, elevators, and X-ray equipment, may cause serious fluctuations of voltage and interfere with the service being provided by RPU to other customers. If such a load is anticipated, the customer must consult with RPU and agree to install such protective devices as may be required so as not to cause damage to any of RPU's equipment or in any way inhibit service to other customers.

402.2 Special Compensation - Special compensation may be required by RPU, from the customer, in those cases where it is necessary for RPU to install non-standard, or larger, facilities than would normally be required to provide satisfactory service. (Refer to Section 700 for additional details).

403 EXCESS FACILITIES

RPU **Engineering** will size utility electric facilities (primary cable and transformer) to serve the load projected by RPU. If a customer desires RPU to install excess facilities, RPU **Engineering** must be advised as soon as possible so the feasibility of such a service can be determined. If RPU determines that excess facilities can and will be provided, the customer will be required to reimburse RPU for the difference in cost between the standard service and the excess facilities, including all labor, materials, and overheads. A written agreement between the customer and RPU shall also be executed at RPU's discretion.

404 REDUNDANT FACILITIES

RPU will provide one set of facilities (such as a set of primary cables and a transformer) to one point of service for each customer. If a customer requires redundant facilities (more than one set of facilities to the same point of service), RPU must be advised as soon as possible so the feasibility of such service can be determined. If RPU determines that redundant facilities can and will be provided, the customer will be required to reimburse RPU for the entire cost of additional facilities, including all labor, materials, vehicle charges, and overheads. An agreement between the customer and RPU may also be executed at RPU's discretion.

405 RELOCATION OR PROTECTION OF RPU FACILITIES

405.1 Responsibilities – It is the responsibility of the customer to arrange for the relocation and/or protection of RPU’s facilities whenever such action is appropriate. Any intended relocation or protection of RPU’s facilities must be reviewed with and approved by RPU in advance.

405.2 Customer Costs – The cost of any change or relocation of RPU’s facilities for the benefit only of the customer, and which has been initiated by the customer, shall be borne solely by the customer. A deposit by the customer may also be required before the changes are made.

405.3 RPU Costs – RPU will bear costs to the extent that a change or relocation benefits RPU. The customer shall not be required to pay for changes necessitated through public improvements by the City, County or State.

405.4 Painting – The customer shall not paint or otherwise modify the appearance of any RPU owned equipment or facilities.

406 REWIRING OR UPGRADING EXISTING FACILITIES

406.1 General – The customer or electrical contractor shall contact RPU when it is necessary to rewire or upgrade an existing electric service. **Rewire or upgrade work shall be in accordance with the following requirements listed below:**

- (1) All RPU Electric Service Rules and Regulations must be followed
- (2) **Where pole mounted CT’s are present, a new CT cabinet complying with Section 610 requirements must be installed by the customer or electrical contractor**
- (3) The customer or electrical contractor is responsible for maintaining the same phase rotation for 3-phase rewire **work**

406.2 Not Permitted – Customers shall not be allowed to convert an existing underground electric service to an overhead service.

406.3 Underground Service – When a **customer with an existing RPU owned underground service lateral performs a Service Upgrade**, the ownership of the underground service lateral will transfer from RPU to the customer.

SECTION 500 – DISTRIBUTED ENERGY RESOURCES

501 GENERAL INTERCONNECTION REQUIREMENTS

The State of Minnesota has interconnection process standards in effect to address interconnection of distributed energy resources (DER) to the distribution grid. Rochester Public Utilities has process and technical requirements that meet the State standards. The customer shall follow RPU's process for projects to install, modify existing, and operate generating equipment interconnected with RPU's distribution system. No generation equipment shall be allowed to operate interconnected to RPU's distribution system without prior approval from RPU and meeting all requirements of RPU, the State of Minnesota, and all other applicable regulations and standards.

502 TECHNICAL REQUIREMENTS

A copy of RPU's rules, technical requirements, process documentation, and applications for operation of Distributed Energy Resources are available through RPU's website <https://www.rpu.org>. If the DER is under 10 MW in size, it will follow the appropriate State of MN mandated process. If the DER size is over 10 MW, contact RPU's Engineering Department for guidance prior to starting design.

SECTION 600 – METERS AND METERING EQUIPMENT

600 GENERAL

This section covers the installation of meters and associated equipment such as current and potential transformers for both overhead and underground services. Further description of RPU requirements for both overhead and underground services is covered in other sections of this booklet. The requirements contained in this section are for services rated 600 volts or less. When services are required at primary voltage (such as 13800Y/7970 volts), the metering requirements and equipment will be determined on an individual basis.

601 METERING EQUIPMENT RESPONSIBILITIES

All metering equipment, with the exception of the meter, current and potential transformers, must be purchased and installed by the customer or electrical contractor. All metering equipment installed must be certified and labeled and have prior approval of RPU's Electric Metering Department. Metering equipment installed without RPU approval will not be energized unless special permission from RPU's Electric Metering Department is obtained. RPU will energize only one (1) set of metering equipment under each contract or application for one class of service.

602 LOCATION OF METERS

602.1 General – Meter locations will be agreed upon by representatives of the customer and RPU, subject to final approval by RPU.

602.2 Clearances – Meters shall be installed in a location with not less than three (3) feet of unobstructed space in front and 30 inches total in width. Meters shall not be located where they are subject to corrosive fumes, dust, vibration or physical damage. Outdoor meters shall not be located in carports, under porches whether open or enclosed, or along walkways or driveways where they might create a hazard to people or be subject to damage by passing objects. Required meter working and safety clearances are shown in Section 1200, Exhibit 11.1. **RPU reserves the right to trim vegetation to meet these clearances for the safety of RPU personnel.**

602.3 Accessibility – Meter locations shall not be hazardous or cause inconvenience to employees of RPU when installing, maintaining, or reading the meters. RPU personnel shall have direct and unobstructed access to RPU's metering equipment at all times. **Indoor meter location(s) shall not be used for any type of storage and shall be free from clutter. RPU will not be responsible for damage, removal, or loss of any items that hinder clearances or the operation of our equipment.**

602.4 Change of Grade - All **existing** meters located outdoors on residential, industrial, or commercial services, where the meter is mounted on a permanent structure, **shall not change the final grade within the unobstructed space requirements identified in Section 602.2 without receiving approval from RPU's Engineering Department.**

602.5 Residential – Residential meter installations shall comply with the following requirements:

- (1) All new services must have the electric meter located outside. **A typical residential underground service meter installation is shown in Section 1200, Exhibit 1**
- (2) Existing residential customers where the meter is located inside shall relocate the meter to the outside **when the service is either altered or upgraded** as defined under Section 100 Definitions
- (3) Any service upgrade or DER installation requires the existing meter socket to be changed to an approved self-contained lever bypass type (if non-compliant)
- (4) **Any service upgrade or DER installation will require the installation of a CT cabinet if pole-mounted CT's are present**
- (5) All new self-contained meter sockets installed under (1), (2), or (3) above must be on the list of approved meter sockets (refer to Section 613)
- (6) **Recessed meter socket installations shall not be permitted**

602.6 Multi-Family Dwelling – Where more than one meter is installed (typical for apartment complexes), meters shall be grouped outdoors at a point accessible at all times to each customer and to RPU personnel.

Exceptions:

- a) *Multi-family dwellings that have 24 meters or more may request to locate the meters inside as long as they are grouped at one (1) location and accessible at all times to each customer and to RPU personnel*
- b) *Multi-family dwellings where the building has over three (3) occupied stories fully above grade, the customer may request in writing for permission to be allowed to install grouped metering panels in multiple locations. The metering locations should be minimized and typically would only be allowed on every 3rd story of the building*

In all cases where multi-metering panels with stacked meter sockets are used, **the installation shall comply with the spacing and clearance requirements shown on the Section 1200, Exhibit 3 drawing (Typical Multiple Metering Arrangement).** Individual apartment disconnects must be connected on the load side of the meter. If the service voltage is 120/208 volts, a fifth terminal located at the 9 o'clock position is required in the socket and must be connected to the service

neutral in accordance with the National Electric Code® (Refer to Section 1200, Exhibit 11.0). Only one (1) meter may be installed under one socket cover in multi-metering panels

RPU will set a minimum of one floor of meters at a time. Meter service charges will start at the time of the meter set.

602.7 Manufactured Homes - RPU will individually meter each **manufactured** home located in all **new manufactured** home **communities** or additions to a mobile home community. Resale of metered electrical energy by the **property** owner will not be permitted in these facilities. **An** individual meter pedestal, with bypass **meter** socket, **or a free standing meter structure** shall be provided by the customer or his representative. Maintenance and repair of the meter pedestal **or free standing meter structure** is the responsibility of the **owner of the manufactured home community**. A typical **free standing meter structure** arrangement is shown in Section 1200, Exhibit 2.

602.8 Industrial and Commercial – Industrial and Commercial self-contained meter installations shall comply with the following requirements:

- (1) All new services must comply with the requirements of Sections 602.1 through 602.4
- (2) Any service upgrade or DER installation requires the existing meter socket to be changed to an approved self-contained lever bypass type (if non-compliant)
- (3) All new self-contained meter sockets installed must be on the list of approved meter sockets (refer to Section 614)

602.9 Commercial Multi-Metering Panels – Installations shall comply with the following requirements:

- (1) All commercial multi-metering panels used in shopping centers, spec. buildings, and multi-tenant **commercial** buildings shall **comply with the spacing and clearance requirements shown on the Section 1200, Exhibit 3 drawing (Typical Multiple Metering Arrangement)**. An approved lever bypass is required on all meter sockets and each individual unit disconnect shall only be connected to the load side of the meter. Each individual meter socket shall have a barrier to isolate the customer's disconnect switch and wiring from the metering area. Only one (1) meter may be installed under one socket cover **in multi-metering panels**. A system neutral is required to each 5 and 7 terminal meter socket in accordance with the National Electric Code®
- (2) Each meter shall have a separate accessible lockable service disconnect wired in cold sequence to be used by RPU

Exception:

In situations where the building has over three (3) occupied stories fully above grade, the customer may request in writing for permission to be allowed to install grouped metering panels in multiple locations. The metering locations should be minimized and typically would only be allowed on every 3rd story of the building

603 GROUPED METERS

In installations requiring more than one meter, the meters shall be grouped and suitably connected such that a meter serves no more than one customer. The spacing and clearance requirements shown on the Section 1200, Exhibit 3 drawing (Typical Multiple Metering Arrangement) also pertain to grouped meter installations where practicable. If deemed necessary by the space available, the meters may be stacked in an orderly fashion. Any dwelling with more than one customer living therein must have an individual meter for each dwelling unit. These meters must be easily accessible to all tenants and to RPU personnel. There shall be an approved type of disconnecting means for each meter, which is lockable in some way to prevent reconnection by other than RPU personnel.

604 METER IDENTIFICATION

604.1 Requirements – If more than one meter is required for a building, each meter socket shall be identified and permanently designated in a suitable manner indicating the particular customer served. An engraved hard plastic or label rated for outdoor use with a minimum height of ½ inch and a minimum font of 28 BOLD will be required at each meter. The tag shall be securely attached to the exterior, non-removable portion of the meter socket and at the individual meter main disconnect. Any other means of identification is not acceptable. **Meters will not be installed until the above requirements are met.**

604.2 Circuit Checking – Each circuit shall be carefully traced and rechecked by the customer or contractor to ensure against errors in wiring that would result in one customer obtaining service through the meter serving another customer. This is especially important when the wiring is concealed. Electric service shall not be energized if meter sockets are not identified. It will be the contractor's/owner's responsibility to correct any errors due to misidentification of meter sockets. RPU reserves the right to charge the building owner and/or electrical contractor for actual costs incurred by RPU to make corrections. See Section 1101.6

604.3 Location Map – In installations requiring more than one meter room/location, a durable and laminated permanent map of all metering rooms/locations within the building shall be installed in the ground level entryway. The location of the map shall be approved by RPU metering personnel prior to installation.

605 OUTDOOR METER MOUNTING

605.1 Outdoor Meters and Meter Mounting Devices – Outdoor meters and meter mounting devices shall be mounted securely on permanent structures such as houses, garages, and other buildings. Where outdoor meters are installed on surfaces that prevent installation of the meter-mounting device in an exact vertical plane, a meter board must be installed or the surface modified in such a manner that the meter-mounting device can be installed vertically.

605.2 Preferred Meter Location(s) – The preferred meter location is within ten (10) feet of the front end of the building (house or attached garage) on a single-family dwelling for new customer hook ups. All meter locations for rewired or upgraded services shall be located outdoors with locations agreed upon between customer, contractor, and RPU personnel with final approval by RPU personnel. RPU has the right to refuse to energize service if these requirements have not been met.

606 INDOOR METER MOUNTING

606.1 Indoor Meter Location(s) – Indoor meters, where permitted, shall be mounted in accordance with the preceding requirements of this section and shall be located as close as possible to the point where service enters the building. Indoor metering equipment shall be mounted securely in a vertical plane on permanent structures in a location free from moisture, high temperature, vibration, dust, or dirt.

606.2 Indoor Meter Room Requirements – Indoor meter room installations shall comply with the following requirements:

- (1) Lighting – multiple lighting fixtures shall be installed to eliminate visibility problems caused by shadows. A minimum of 30 lumens per square foot shall be required for each meter location
- (2) Labeling – meter room doors shall be labeled with “Electric Meter Room” and “No Storage” signs

607 METER CONNECTIONS

607.1 General – The customer shall provide the necessary wiring for the meter set with the wiring so arranged that the line (supply) side can be connected to the top terminals of the socket and the load side to the bottom terminals. All conductors shall extend into the meter socket and shall be of equal length and at a minimum distance equal to the length of the socket trough. All neutral conductors must be insulated.

607.2 Underground Services – Underground service installations shall comply with the following requirements:

- (1) Line side neutral wire shall be identified in accordance with the National Electrical Code®
- (2) An expansion joint shall be furnished and installed by the customer on all new underground residential meter installations. The expansion joint shall be a minimum eighteen (18) inch length Schedule 80 PVC installed at the bottom of the meter housing
- (3) Sufficient slack **shall** be left in the underground cables to make up for any ground shifting due to settling, **ground shifting**, or extreme cold

608 WIRING RESTRICTIONS ON METER/METER SETS

608.1 General – Meters and metering sets shall comply with the following requirements:

- (1) No customer wiring shall be permitted to be connected to the metering, secondary wiring, or under the terminals of the meter
- (2) No part of the metering set shall be used as a junction box for the customer's wiring
- (3) **All line side (non-metered) conductors shall be installed within a continuous length of conduit that emerges from the ground up to the meter socket. Junction boxes, conduit bodies (e.g. LB's) or other devices are not permitted**
- (4) No non-RPU owned equipment (**such as surge suppression, generator transfer switch, etc.**) that utilizes a plug-in device designed to fit between the meter and the meter socket shall be permitted

609 METER TESTING

609.1 Testing Request – Any customer, who believes that a meter is failing to register properly the use of electricity, may request a meter check by contacting an RPU Customer Care Advisor. RPU will test the meter using standard calibration equipment and generally accepted test procedures within a reasonable period of time. Customers who request additional meter tests within a twelve (12) month period may be charged for the additional tests. **See RPU rate schedule – Miscellaneous Fees – Electric Utility.**

609.2 Meter Error Standard – Whenever a watt-hour meter is found upon test to have an average error of more than two percent (2%) from one hundred percent (100%), a recalculation of bills for service will be made on the basis that the meter should be one hundred percent (100%) accurate with respect to a working test standard.

609.3 Meter Inaccuracy (Working) – If the period of inaccuracy cannot be determined, it will be assumed that the metering equipment has become inaccurate at a uniform rate since it was installed or last tested unless there is a

valid reason to use another method. Recalculation of bills is based upon RPU Board Policy for **Adjustment of Utility Services Billed**.

609.4 Meter Inaccuracy (Failure) – When the average error cannot be determined by test due to complete failure of all or part of the metering equipment, then an estimate of the quantity of energy consumed based upon available data will be used to determine the adjusted bills.

610 METER SEALS & LOCKS

All connections to RPU service equipment shall be made by RPU Electric Metering Department personnel only. Unauthorized connections to or tampering with any RPU meter, associated equipment or meter seals, or indications or evidence thereof subjects the customer to immediate discontinuance of service, prosecution under the laws of Minnesota, adjustment of prior bills for services rendered, and reimbursement to RPU for all extra expense incurred on the account, **including a meter tampering fee**. In addition, when the unauthorized connections or tampering involve an inside meter, the customer shall, at his own expense, relocate all service equipment and metering facilities outside the building.

611 INSTRUMENT TRANSFORMER METER INSTALLATIONS

RPU **does not furnish** instrument rated meter sockets. Please contact a local electrical distributor of your choice to purchase an RPU approved instrument rated meter socket.

611.1 Where Required – It will be necessary for RPU to use instrument transformers in the metering installation under the conditions listed below:

- (1) Single Phase Service: When any single phase service exceeds 320 continuous amps in size or exceeds 240 volts
- (2) Three Phase Service: When any three phase service exceeds 320 continuous amps in size or exceeds 240 volts

611.2 Instrument Transformer Provision & Location – All instrument transformers will be furnished by RPU and delivered to the customer/contractor to install into an approved instrument transformer cabinet. The instrument transformer cabinet will be located before the customer service entrance disconnect switch.

611.3 Secondary Metering Instrument Transformer Cabinet Requirements – Cabinet shall be furnished and installed by the customer. This includes all services, either overhead or underground. All cabinets must be certified and labeled, approved by RPU personnel and meet all National Electric Code® requirements prior to installation. All cabinets must conform to the following:

- (1) The meter socket shall not be mounted to the door of the instrument cabinet and must be mounted within 20 feet of the instrument cabinet
- (2) Cabinets must be UL approved and be the correct NEMA class for the area environment in which it is installed
- (3) Minimum instrument transformer cabinet sizes are as follows:
 - a) 250 volts and below: 48 inches high, 25 inches wide, and 15 inches deep
 - b) 251 – 600 volts: 48 inches high, 36 inches wide, and 15 inches deep
- (5) The door must have a single closure with provisions for locking with a standard padlock through the handle
- (6) Cabinet must be hinged on the right or left side only
- (7) Cabinet shall not be used as a junction box or service connection cabinet
- (8) Only RPU metering transformers may be contained therein
- (9) A 1-inch conduit installed between the cabinet and meter socket location is required
- (10) Cabinet must accept bar-type current transformers on all services 1200 amps or less
- (11) Customer is required to label the line side and load side of the conductors within the instrument transformer cabinet

611.4 New Service Secondary Metering Requirements – For any new electrical services requiring the use of instrument transformers, the instrument transformers must be mounted in an approved instrument transformer cabinet complying with the requirements of 611.3 above and be located as follows:

- (1) **Underground Service from Pad-Mounted Transformers:** When service is supplied underground from a pad-mounted transformer, the location of the instrument transformer cabinet must be approved by RPU during installation
- (2) **Overhead Services:** When service is provided by overhead service drops, approved outdoor instrument transformer cabinets will be required. Location of transformer cabinets will have final approval by RPU's Electric Metering Department before installation. No open air CT's or PT's will be allowed
- (3) **Indoor Mounted Instrument Transformers:** Instrument transformers installed indoors must have prior approval from RPU's Electric Metering Department, and meet the requirements of Section 611.3

611.5 New Indoor Primary Metering Equipment Requirements

- (1) When primary metering service is to be installed, the customer shall furnish a compartment or switchgear cubicle to house the primary current and potential instrument transformers. All current and potential instrument transformers shall be rated for metering accuracy as approved by the RPU's Electric Metering Department. The metering point shall be located electrically between the customer's main disconnect and customer's circuits ("cold sequence" metering arrangement)
- (2) When practical, RPU may request that the customer install the primary current and potential transformers per RPU specifications. (Contact a Customer Care Advisor to obtain Engineering assistance.)

611.6 New Outdoor Primary Metering Equipment Requirements – When outdoor primary service is to be installed, RPU may elect to utilize either a pole-mounted or pad-mounted primary metering equipment set. Outdoor primary metering units are furnished and installed by RPU. Sharing of the material and installation costs for primary metering will be determined on a case-by-case basis.

611.7 Existing Service Emergency Repairs – In situations requiring emergency repairs to an existing electrical service where instrument transformers are installed in any location other than an instrument transformer cabinet, the customer/contractor must receive prior approval for the new mounting location of the current transformers from RPU's Electric Metering Department. These types of installations include, but are not limited to:

- (1) Instrument transformers mounted on a pole
- (2) Instrument transformers installed inside a distribution transformer
- (3) Instrument transformers installed inside customer switchgear

612 SELF-CONTAINED METER INSTALLATIONS

612.1 New Installation Requirements – In general, RPU will install self-contained meters (meters without instrument transformers) on single or three phase services (240V or less) where the service rating is 400 amps or less (Class 320 meter socket). Where such metering is to be used, the customer shall provide a ringless lever-operated bypassing socket (Refer to Section 614). Such meter sockets permit a continuation of service upon removal of the meter for testing or maintenance. If a lever-operated bypass meter socket is not installed, the service will not be energized.

612.2 Existing Service Repair – In situations requiring repair work to alter the existing electrical service, the customer/electrical contractor shall bring the electrical service into compliance with the requirements of Section 602.5 for Residential or Section 602.8 Industrial and Commercial.

Exception:

Minor repair work (such as a direct replacement of a main circuit breaker or fuse holder within a panel, etc.) shall be exempt from the above requirement. Contact RPU's Electric Metering Department for approval when claiming this exception

613 MASTER METERING INSTALLATIONS

613.1 All new residential units will be individually metered.

Exception Provided in Minnesota Rule 326B.106 Subd. 12:

Buildings intended for occupancy primarily by persons who are 62 years of age or older or disabled, supportive housing, or buildings that contain a majority of units not equipped with complete kitchen facilities, shall be exempt from the provisions of this subdivision. For purposes of this section, "supportive housing" means housing made available to individuals and families with multiple barriers to obtaining and maintaining housing, including those who are formerly homeless or at risk of homelessness and those who have a mental illness, substance abuse disorder, debilitating disease, or a combination of these conditions."

- (1) A customer claiming the above exception above takes all legal responsibility for proving the exemption for the life of their building
- (2) Any customer claiming the exception above must provide RPU, in writing, a statement that they are claiming an exception under Minnesota Rule 326B.106 Subd. 12 and why they feel their building meets the requirements for an exception. RPU does not determine the validity of the claimed exception and this required filing is for RPU's documentation only

613.2 All new commercial or industrial units will be individually metered.

Exceptions must be approved by RPU's Electric Metering Department.

613.3 Sub-metering by others for the purpose of charging individual occupants based on measured use must be in accordance with statutory requirements. Sub-metering by others for information purposes or to control the use of electric power for energy is permitted.

614 APPROVED METER SOCKETS

Meter installations made with unapproved meter sockets will not be energized, or subject to disconnection if non-approved equipment is installed. Refer to the **following** table for a list of meter sockets approved for installation by RPU:

RPU APPROVED METER SOCKETS		
<u>SELF CONTAINED</u>	<u>SERVICE VOLTAGES</u>	<u>APPROVED MFG./PART NUMBER</u>
4 Terminal 320A Max (Residential, 1-Phase)	120-240V, 3 wire Single Phase	Heavy duty, ringless type, with lever bypass
5 Terminal 320A Max (Residential, 1-Phase)	120-208V, 3 wire Single Phase	Heavy duty, ringless type with lever bypass
7 Terminal 320A Max (Commercial, 3-Phase)	120-208V 4-Wire Three Phase	Heavy duty, ringless type with lever bypass
<u>INSTRUMENT RATED</u>	<u>SERVICE VOLTAGES</u>	<u>APPROVED MFG./PART NUMBER</u>
6 Terminal (Residential or Commercial, 1-Phase)	120-240V, 3 wire Single Phase	Milbank: UC7478-XL-WC-271 Brooks: 602U3010C6-1666 Durham: BOMSOD6T-RPU Tesco: 9070113-CL
13 Terminal (Residential or Commercial, 3-Phase)	120-208V 4-Wire WYE 277-480V 4-Wire WYE	Milbank: UC7478-XL-WC-271 Brooks: 602U3010C6-1666 Durham: BOMSOD6T-RPU Tesco: 9070112-CL

615 SERVICE AT 480 VOLTS

All 277/480V metering services will require the installation of CT's and VT's. RPU will supply all metering CT's and VT's at no cost to the customer/contractor.

Exception:

Self-contained services (200A or smaller) supplying MnDOT lighting operating at 240/480V and fed from a single phase transformer only supplying the lighting service shall be exempt from the above requirement

616 LOCATION OF HIGH-LEG IN METER SOCKET ON 240/120 VOLT, 3-PHASE SERVICES

The conductor with the higher voltage to ground must be connected to the terminal on the right side. The high-leg conductor must be identified as required by the National Electric Code®. Meter sockets with the high-leg in the wrong position will not be energized. Incorrectly wired sockets will be subject to disconnection until wiring is corrected.

617 REMOVING RPU SEALS, LOCKS AND METERS

Disconnection of RPU metering equipment and cutting of seals or locks is not allowed, and will result in meter tampering fees.

618 CUSTOMER GENERATION

Refer to Section 500 – Distributed Energy Resources for metering requirements pertaining to DER facilities interconnected to RPU’s distribution system.

619 PROPER GROUNDING/BONDING OF METER SOCKETS & SERVICES

619.1 Proper Grounding/Bonding – Service equipment and enclosures may need to carry heavy fault currents in the event of a ground-fault. For this reason, it is imperative that meter sockets and conduits be adequately bonded to the neutral and to the ground. Bonding is to be done by threaded couplings and threaded bosses in a rigid metal conduit system where the joints will be made up wrench tight. Locknuts and bushings do not fulfill the requirement of bonding at service equipment. Grounding bushing (with bonding jumpers), bonding locknuts, threaded conduit hubs, or other means are approved (Refer to National Electric Code® Article 250). All metering conduits and sockets must be properly grounded. If PVC conduits are used, grounding conductors must be provided and installed by the customer or electrical contractor in accordance with the National Electric Code®. Electric services will not be connected if improperly grounded/bonded upon inspection.

619.2 Neutral for 5 and 7 Terminal Sockets - A system neutral is required to each 5 and 7 terminal socket. Conductor shall be sized in accordance with the National Electric Code®.

620 CUSTOMER DISCONNECT SWITCH

620.1 Location – Disconnect switches shall be installed in a location that meets the same requirements for location as those for electric meters (Refer to Section 602)

620.2 Residential Customers – Individual Customer disconnect switches shall be connected on the load side of the meter. No customer devices, e.g. surge suppressors, load management equipment, etc., may be installed on the line side of the meter.

620.3 Non-residential Customers – Each installation must have a separate securable disconnect, installed on the load side of the meter, and accessible to RPU at all times. If the building is a multi-tenant building, each non-residential customer must have a separate securable disconnect installed on the load side of the meter. The securable disconnect shall be labeled and mounted adjacent to the meter location.

621 SPECIAL SOCKETS

All special sockets, such as ganged meter sockets and free-standing metering pedestals, must have RPU Engineering approval prior to installation.

622 RPU OWNED EQUIPMENT

Any metering equipment furnished by RPU, such as meters, instrument transformers, relays, totalizers, test switches, etc., remain the property of RPU. If the equipment has to be removed or disconnected for any reasons, please call RPU so that the equipment can be picked up.

623 TEMPORARY REMOVAL OF CUSTOMER OWNED METER SOCKETS

Any meter socket removal request will be at the discretion of RPU's personnel. Should RPU's personnel not be able to perform the work, it will be up to the customer to hire an electrician/contractor to perform the task. If at any time safety is a concern, RPU will have the service de-energized to perform the work. The customer/contractor shall contact RPU two (2) business days in advance to schedule the temporary removal of the meter socket for siding purposes.

624 PULSE INITIATING DEVICE

624.1 Customer Request – To initiate a request for installation of a pulse-initiating device, the customer shall contact RPU. The customer should submit, in writing, all technical information concerning the customer's load monitoring equipment to RPU for review. RPU will determine what type of pulse and the amount of pulses available in a given time interval.

624.2 Installation – Upon customer and RPU acceptance, RPU will provide and install a pulse-initiating enclosure on a customer's existing meter socket and supply the wiring from the electric meter to the utility side of the pulse-initiating enclosure. The customer owns and is responsible for maintaining the pulse-initiating enclosure, all associated wiring, and hardware on the customer's side of the pulse-initiating enclosure. All installed wiring must be in accordance with the requirements of the electrical code governing such installation.

624.3 Typical Pulse-Initiating Device Installation Detail – Refer to the detail on the following page for a typical wiring arrangement for a pulse initiating device installation:

Typical Pulse-Initiating Device Installation

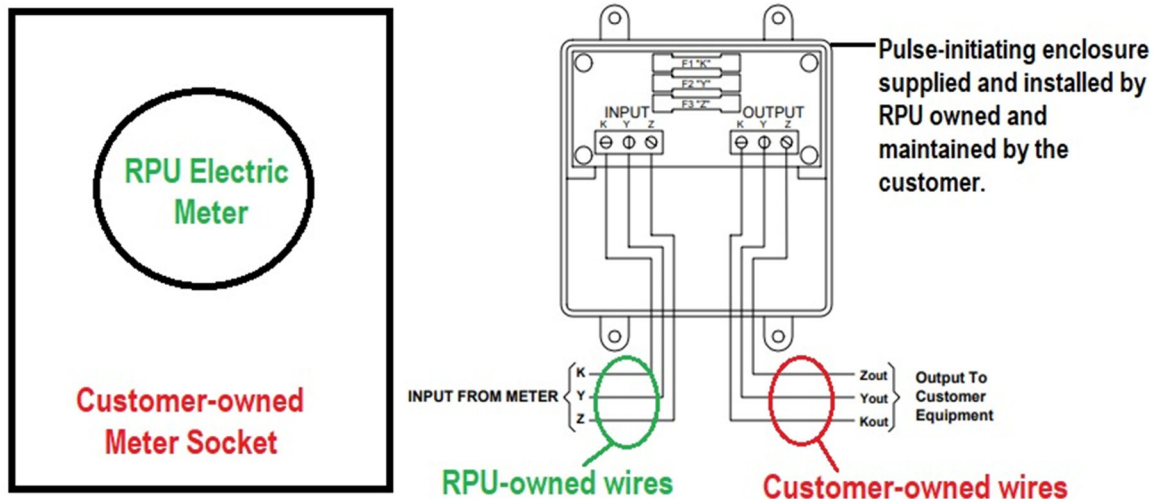

624.4 Responsibilities and Liability – RPU’s responsibility and liability end on the utility side of the pulse-initiating enclosure. RPU reserves the right to deny or cancel a customer’s request or existing installation for pulses if the customer’s service doesn’t meet the requirements listed above or the technology is unavailable.

624.5 Interruption and Removal – RPU may interrupt or permanently remove pulses at any time and notify the customer of any change to the pulse values or when it becomes necessary for equipment maintenance or availability.

SECTION 700 – CUSTOMER UTILIZATION EQUIPMENT

The customer's service entrance and utilization equipment shall be installed in accordance with all local, state, and National Electrical Code® requirements. It is the intent of this section to provide the customer with recommendations concerning factors that can affect both RPU and the customer in the selection, installation, maintenance, and operation of the customer's utilization equipment. If concerns arise that are not covered in this section, please contact a RPU Customer Care Advisor for assistance.

701 PROTECTION OF CUSTOMER EQUIPMENT

701.1 General – The customer is advised to provide adequate protection against the effects of outages or voltage spikes in accordance with the National Electric Code® or other pertinent sources of information for all types of motors and other equipment. Equipment that should be protected includes, but is not limited to:

- (1) Motors
- (2) Computers
- (3) Electronic Equipment
- (4) Equipment in which computers or electronics form an integral operating part

701.2 Protection Conditions – Equipment should be protected under all conditions, including:

- (1) Overload
- (2) Voltage Loss
- (3) High or low voltage
- (4) Phase loss (e.g. single phasing on polyphase motors)
- (5) Re-establishment of service after any of the foregoing
- (6) Phase reversal
- (7) Motors that cannot be subjected to full voltage on starting
- (8) Harmonics or wave form irregularities

701.3 Failure to Protect – Failure to provide such protection may result in needless damage to equipment and the expense of delay and repair.

701.4 Sensitive Electronics – Sensitive electronics, such as microprocessor-based home electronics and business computers, are susceptible to damage due to voltage spikes or surges. Before any microprocessor-based electronics are installed:

- (1) Wiring practices that meet manufacturer specifications need to be assured (e.g. proper grounding and dedicated circuits are important)
- (2) Consideration should be given to installation of transient voltage surge suppression
 - a) At the main service entrance
 - b) At the point of use
- (3) An uninterrupted power supply (battery backup) should be considered if a momentary voltage dip or outage would cause loss of data

702 MOTOR STARTING CURRENTS

702.1 General – Typically, all motors require a starting current substantially greater than their normal running current. Where starting currents are excessive, an abnormal drop in supply voltage will result. In order to minimize the unfavorable effects of such voltage drops, it is essential that the customer's motors do not exceed the allowable starting characteristics as shown in Table 430-251(A and B) of the National Electric Code®.

***NOTE:** Customers planning to install any motor larger than 5 HP single phase or 25 HP three phase, must contact RPU Engineering. Motor installations that cause power quality problems for other customers shall be corrected at the owner's expense.*

702.2 Voltage Flicker – RPU uses IEEE Standard 141 (IEEE Red Book) as a guideline for the level of allowable flicker. Customers are not allowed to start any load on RPU's system that produces unacceptable levels of flicker which affect other customers. Customers are responsible for correcting unacceptable flicker problems in a timely manner when notified by RPU.

703 POWER FACTOR

703.1 Requirements – In order to improve the efficiency of RPU's distribution system, the customer's utilization equipment shall maintain an average power factor as close to unity as possible.

703.2 Penalties – Some of RPU's rate schedules include a demand charge and a penalty for an average power factor that is less than 95%. Details of the method of billing for such customers can be obtained from an RPU Customer Care Advisor. For new services, it is suggested that the customer's utilization equipment be designed for operation at high power factor or with capacitors that are switched on and off with the equipment. Refer to Section 1108, Table 11.1 for correcting customer's power factor.

703.3 Calculation – RPU will calculate the power factor of customers in designed rate classes by installing a varhour meter. Refer to Section 601 for customer's responsibilities in providing metering equipment.

704 FAULT CURRENTS

The customer's service equipment and other devices shall be adequate to withstand and interrupt the maximum available fault current. For single-family residences with service equipment rated 200 amperes maximum and 120/240 volts, single phase, equipment shall have a minimum interrupting rate of 10,000 amperes symmetrical and other equipment shall be braced to withstand that minimum value. Refer to Section 1003 for more information.

705 WIRING ADEQUACY

The National Electrical Code® (NFPA No. 70) specifies the adequacy of wiring with respect to safety; however, such installations may not be efficient or adequate for future expansion of electrical use.

706 CUSTOMER-OWNED GENERATING EQUIPMENT

Unless authorized by written agreement, electric generating equipment installed by the Customer shall not be interconnected or operated in parallel with RPU's distribution system. The customer shall own, install, operate, and maintain electrical interlocking equipment which will prevent parallel operation and such equipment shall be approved by RPU prior to installation.

706.1 Distributed Energy Resources (DER) – For generation and storage systems designed to operate in parallel with RPU's distribution system, refer to Section 500 for requirements governing this type of installation.

707 CUSTOMER'S OBLIGATIONS

707.1 Increased Load – In the event the customer desires to increase load materially, such as adding electric heat, increased motor loads, etc., they shall give RPU sufficient advance notice, so that RPU may provide added facilities if necessary. If the customer fails to notify RPU and RPU's equipment is damaged as a result of such increased load, the customer shall reimburse and make payment to RPU for all such damages.

707.2 Balancing of Load – Except in the case of three-phase, four-wire delta services, the current unbalance in three-phase services shall not exceed 10 percent of the current that would be required at maximum load under balanced conditions.

707.3 Total Harmonic Distortion (THD) Requirements

- (1) Nonlinear Load – The application of any nonlinear load by the customer (e.g. static power converters, arc furnaces, adjustable speed drive systems, etc.) shall not cause voltage and/or current Total Harmonic Distortion (THD) levels greater than industry accepted levels on RPU's electric system at the point of power delivery to the customer's facility (Refer to IEEE Standard 519)
- (2) Nonlinear Load Disclosure – the customer shall disclose to RPU all nonlinear loads prior to connection. RPU may test the customer's load to determine the THD levels
- (3) Nonlinear Load Responsibilities – It shall be the responsibility of the customer to assure that the THD requirements are met, including the purchase of necessary filtering equipment. Any load found not in compliance with this policy shall be corrected immediately by the customer at the customer's expense. If not corrected, RPU may disconnect service to the customer's facility
- (4) Nonlinear Load Damages – The customer shall be liable for all damages, losses, claims, costs, expenses and liabilities of any kind or nature arising out of, caused by, or in any way connected with the application by the customer of any nonlinear load operating with maximum THD levels in excess of the values stated in Section 707.3(1) above. The customer shall hold harmless and indemnify RPU from and against any claims, losses, costs of investigation, expenses, reasonable attorney's fees, damages and liabilities of any kind or nature arising out of, caused by, or in any way connected with the application by the customer of any nonlinear load operating with maximum THD levels in excess of the values stated in Section 707.3(1) above

SECTION 800 – OVERHEAD SECONDARY SERVICES

801 SCOPE

801.1 Availability – The requirements of this section apply to all residential, commercial, and industrial customers within RPU's service territory where overhead facilities are present.

801.2 Installations Permitted – RPU will supply and maintain all existing overhead secondary services (600 volts or less), at the voltages and under the conditions specified in other sections of this standard. Any upgrade or modification request to an existing overhead secondary service must be reviewed and approved by RPU Engineering prior to construction.

801.3 Installations Not Permitted – An overhead secondary service (600 volts or less) in a residential, commercial, or industrial location that meets any of the conditions listed below:

- (1) Any new service drop request to establish permanent service to the customer's property without a written waiver on company letterhead provided by the RPU Engineering Department
- (2) Any new service drop request that would establish a second permanent service to the customer's property or buildings such as a detached garage
- (3) An existing service drop upgrade request that exceeds 400 amperes in size

801.4 Violations – All upgraded, modified or repaired services shall comply with all applicable NESC clearance requirements. The customer is responsible for rectifying clearance violations caused by them or the previous property owner/tenant.

802 TRANSFORMER LIMITATIONS

802.1 Maximum Size – The maximum standard overhead transformer size installed by RPU will be either one 50 kVA transformer for a single-phase application or three 15 kVA transformers for multiphase applications. If a larger transformer size is required for a particular application, it shall be a pad-mounted type.

802.2 Number of Secondary Services – One (1) or more secondary services may be supplied from a transformer; the number of services from a transformer shall be determined by RPU Engineering depending upon the application.

803 SERVICE DROP CONDUCTORS

803.1 Configuration – The service drop will be a twisted wire triplex (3 wires) or quadruplex (4 wires) configuration from the distribution system to the point of attachment on the customer's premises.

803.2 Existing Services – The service drop may either be a twisted wire or open wire configuration. If necessary for various reasons, RPU may change a service from an open wire to a twisted wire configuration.

804 REQUIRED CLEARANCES

804.1 Roofs, Balconies & Windows/Doors – The service drop must be so located that the minimum clearance as specified in the latest editions of the National Electrical Code® and the National Electric Safety Code® is maintained. Illustration drawings of the clearances required are shown in Section 1200, Exhibits 4, 4.1, and 4.2. Please contact RPU's Engineering Department if there are any questions about the clearances depicted. RPU will not energize an electric service with an observed clearance violation.

804.2 Patios, Pools & Hot Tubs – The service drop must be located so that the minimum clearance as specified in the latest editions of the National Electrical Code® and the National Electric Safety Code® is maintained. Illustration drawings of the clearances required are shown in Section 1200, Exhibits 4.3, 4.4 and 4.5. Please contact RPU's Engineering Department if there are any questions about the clearances depicted. RPU will not energize an electric service with an observed clearance violation.

805 SERVICE ATTACHMENT PROVISIONS

805.1 General Requirements – The customer shall be responsible to comply with all the service attachment requirements listed below:

- (1) Eye bolts, where required, shall be galvanized, 3/8-inch minimum diameter, and installed by the customer. Screw point or lag type attachments (4 inches of thread minimum) are only permitted on rewires with RPU approval
- (2) Service drop conductors shall not be attached to fire walls, parapet walls, or chimneys
- (3) Where not accessible by a service truck, the overhead service attachment must not exceed eighteen feet (18') above ground level

805.2 Building Attachment – A solid point of attachment for supporting the service drop on the building shall be provided by the customer at a point which will comply with previously stated clearances in Section 804. Where the required heights and clearances cannot be maintained by a point of attachment on the building, the customer shall provide a service mast which is of a permanent nature and of sufficient strength to support the service drop at the required

minimum clearance. Illustration drawings of the attachment clearances and service mast installations are shown in Section 1200, Exhibits 6 and 6.1.

NOTE 1: *In no case shall the point of attachment be more than 5 foot above the roof surface unless prior approval is obtained by RPU Engineering Department.*

NOTE 2: *In no case shall the point of attachment be more than 18 feet in the air unless the location has unobstructed access to an RPU bucket truck and the property owner takes the full responsibility of site restoration for any damage caused by RPU bucket truck access. RPU will, at its sole judgement, determine if there is adequate unobstructed access*

NOTE 3: *RPU reserves the right to decline to connect its service drop to an extension support, which, in its judgment, constitutes a hazard to life or property.*

806 OVERHEAD SERVICE MAST REQUIREMENTS

806.1 Unguyed Mast Service Drop Length Limitations – Table 8.1 below shows the maximum service drop lengths allowable for triplex and quadruplex service drops attached to unguyed riser masts:

TABLE 8.1 - MAXIMUM SERVICE DROP LENGTHS						
SERVICE ENTRANCE SIZE	RISER MAST CONDUIT SIZE FOR ABOVE THE ROOFLINE (RIGID OR INTERMEDIATE)	SERVICE ATTACHMENT HEIGHT ABOVE SUPPORT (FT)				
		1.5	2	3	4	5
		MAXIMUM SERVICE DROP LENGTH (FT)				
100A	2"	125	100	75	75	50
	2-1/2" OR 3"	150	150	100	100	75
	3-1/2" OR 4"	150	150	150	125	100
200A	2"	100	75	50	50	50
	2-1/2" OR 3"	150▲	100	75	75	75▲
	3-1/2" OR 4"	150▲	150▲	125▲	100	75
400A	2-1/2" OR 3"	100	100	75	50	50
	3-1/2" OR 4"	125	100	100	75	75

APPLICATION AND CONDITIONS FOR ABOVE TABLE:

- ▲ Marked Span lengths indicate that 25 feet must be subtracted from the value shown if service drop is quadruplex
- EMT (thinwall conduit) is not acceptable for any portion of the service mast

806.2 Guyed Mast Service Drop Length Limitations – Riser masts that support spans longer than those shown in Table 8.1 must be guyed or braced to withstand the following maximum actual service drop tension values:

<u>Service Entrance Size</u>	<u>Maximum Actual Tension</u>
100A	1500 Lbs.
200A	2000 Lbs.
400A	3500 Lbs.

806.3 Customer Responsibility – Customer's portion of the overhead service mast shall consist of **the conduit from the meter socket**, a weather head, and the wire from the line side of the meter socket up the mast to the weather head. Tails shall be left on the customer's service wires extending a minimum of three (3) feet beyond the weather head. The neutral wire shall be identified and shall be continuous (no cut) from the weather head to the entrance switch (unless otherwise approved by RPU)

SECTION 900 – UNDERGROUND SERVICES

901 NEW RESIDENTIAL DEVELOPMENTS

901.1 Point of Delivery – RPU will designate a point of delivery for the connection of the customer's secondary underground service. The point of delivery may be the secondary terminals of a pad-mounted transformer, service pedestal, or secondary vault. In general, RPU will install, own, operate, and maintain all facilities on the source side of the point of delivery, including the junction cabinet and connections; the customer will install, own, operate, and maintain all secondary cables, conduit, and related service equipment specified in other sections of this publication on the load side of the point of delivery.

901.2 Point of Delivery Location – Points of delivery will be located within **the general utility or RPU specific** easement area along or near a front or rear property line unless it is necessary or desirable to designate locations which are closer to the metering point(s). In such cases, the customer will be charged for the installed cost of any additional lengths of underground distribution cable and conduit from the property line to the point of delivery. Such charges shall be in addition to any other charges specified herein.

901.3 Responsibilities – Additional information regarding RPU and customer responsibilities for URD installations is provided in Section 1200, Exhibit 9.

902 RESIDENTIAL UNDERGROUNDING IN OVERHEAD AREAS

902.1 Customer Initiated – Customers residing in residential zones presently served by overhead lines may request underground electric service. Customers intending to relocate, upgrade, or replace an existing overhead service may request underground service. In either situation, the customer shall own, operate, and maintain the facilities specified in Section 901 above.

902.2 Additional Customer Responsibilities – Customers replacing an existing overhead service with an underground service will install the service conductors to an RPU installed secondary pedestal **or padmount transformer**. The location of the **RPU equipment** will be determined by RPU. The customer should contact RPU's Engineering Department for more details prior to proceeding.

903 UNDERGROUND SERVICE TO COMMERCIAL & INDUSTRIAL CUSTOMERS

903.1 Where Required – RPU requires the underground installation of primary and secondary distribution service to new commercial and industrial structures.

903.2 Point of Delivery – RPU will designate a point of delivery for the connection of the customer's secondary underground service lateral. The point of delivery will normally be the secondary terminals of a pad-mounted

transformer placed at a mutually agreeable location on the customer's property, as close as practicable to the metering point.

903.3 RPU Owned Material – RPU will install, own, operate, and maintain the primary underground cable, the distribution transformer, and the secondary connections at the distribution transformer.

903.4 Conduit Required (RPU Underground Facilities) – If underground primary distribution facilities are located on the customer's property, the customer or their electrical contractor shall provide the conduit from a designated point of interconnection to the distribution transformer.

903.5 Conduit Required (RPU Overhead Facilities) – If overhead main distribution facilities are located on or adjacent to the customer's property, the customer shall provide conduit from the riser pole, including the long sweep elbows, to the pad-mounted distribution transformer. Refer to Section 1200, Exhibit 8 for details.

903.6 Concrete Transformer Pad – The customer shall install, own and maintain a concrete transformer pad constructed to RPU specifications.

- (1) If the transformer is located in an area subject to physical damage (e.g. from vehicular traffic), RPU will require the customer to furnish and install an approved means of protection (such as bollards).
- (2) The customer will be required to construct or position the concrete transformer pad in such a way to avoid other types of transformer damage, such as corrosion resulting from snow-melt chemicals.

903.7 Customer Owned Material – The customer shall install, own, and maintain all secondary cables, conduits, and cabinets from the transformer or secondary pedestal to the building service entrance.

- (1) Secondary Bus Duct – RPU must approve the design of all secondary bus duct and cable bus designs. The installation may be inspected by RPU and the secondary connections to the transformer and the transformer side of the connection cabinet will be made by RPU.
- (2) Customer Coordination – It is the customer's responsibility to coordinate with and provide the necessary information to RPU to assure that adequate connections are made at the secondary terminals of the transformer.

903.8 Metering – RPU will furnish and install the meter set in accordance with the requirements of Section 600.

903.9 Maximum Secondary Connections – The maximum number of secondary connections available shall be:

- (1) Single Phase: Six (6) 350 MCM conductors per phase
- (2) Three Phase:

TRANSFORMER SIZE	# OF CONDUCTORS PER PHASE
45 KVA	3
75 KVA to 500kVA	6
750kVA to 2500kVA	10

- (3) The maximum size secondary conductor to be installed in a 3-phase transformer is 500 MCM. Conductors may be aluminum or copper and parallel conductors shall be of identical wire size

Exception: Where the customer's NEC ® service ampacity requirement (as determined by others) exceeds the maximum allowable cable quantity shown above for 500 MCM copper conductors at 90°C temperature rating, contact RPU's Engineering Department for assistance.

- (4) Any service requiring more conductors per phase than listed above must utilize a customer provided secondary connection cabinet complying with the requirements of Section 904

903.10 Manhole Secondary Connections – Secondary cables installed in an RPU manhole must be copper conductor.

904 SECONDARY CONNECTION CABINETS

904.1 General – Where secondary connection cabinets are necessary, the following requirements apply:

- (1) Cabinet assemblies will be suitable for the installation and comply with all RPU and National Electric Code® requirements
- (2) Cabinets shall be constructed with provisions for bar-type or donut-type current transformers
- (3) Conduits from service equipment to the connection cabinet and from the transformer to connection cabinet will be furnished and installed by electrical contractor as concrete pads are being formed and poured. Conduit systems shall meet RPU requirements. Above-grade raceway from the transformer to the connection cabinet is not allowed.

904.2 Clearance Requirements – Secondary connection cabinets must be installed such that the minimum clearance requirements for pad-mounted transformers specified in Section 1200, Exhibit 7 are maintained.

904.3 Inspections – During the required transformer pad inspection, if the secondary connection cabinet is found to be in violation of the minimum required pad-mount transformer clearances, the inspection will be marked as ‘FAILED’. The contractor will need to correct the observed deficiencies and submit a new form for inspection.

905 TRANSFORMER CLEARANCES

Where pad-mounted transformers are installed, the minimum clearances specified and shown in Section 1200, Exhibit 7 must be maintained. Fences, shrubbery, manholes, junction boxes, and trees may be installed by the customer if the specified clearances are maintained, grade is not altered, and the underground cable is not endangered.

906 OTHER PAD-MOUNTED EQUIPMENT CLEARANCES

Where pad-mounted equipment such as capacitor banks, switchgear, or primary metering cabinets are installed, the following minimum clearances shall be provided:

- (1) Ten (10) feet in front of the access doors
- (2) Three (3) feet from the sides and/or back of the equipment

The above minimum clearances must be at the same grade as the equipment.

907 WINTER INSTALLATION

The customer shall be required to pay a per foot additional fee for underground cable installation, at the customer's request, after frost has been established in the ground to an average depth of 6 inches or more. The amount of the frost fee depends on the depth of the frost. RPU may require that the estimated frost charges be paid in advance of performing work.

908 INSTALLATION IN UNSUITABLE SOILS

The customer shall be required to pay an additional fee if unsuitable backfill material is encountered during the installation of RPU's facilities. The fee will be based on the cubic feet of unsuitable backfill material encountered by RPU or our contractor during installation. RPU may require that the customer pay an estimated fee prior to performing the work.

909 TOTAL UNDERGROUNDING

RPU does not install **new** underground vaults, manholes, or submersible transformers on customer property. If the presence of permanent structures up to the property lines, or other conditions, precludes the installation of pad-mounted equipment on the customer's property, primary service will be provided **by RPU in accordance with Section 304.**

SECTION 1000 – TRANSFORMERS AND TRANSFORMER DATA

1001 TRANSFORMERS

1001.1 Ownership – Necessary transformers will be installed and maintained by RPU in accordance with its established Rate Schedules and Electric Service Rules and Regulations.

1001.2 Requirements – RPU will not furnish transformers unless they are of standard size and voltage as established by RPU. The customer shall notify RPU in advance of any change in the customer's load requirements that may affect the installed transformer capacity.

1002 GROUNDING

1002.1 Grounded System – All service systems that operate below 600 volts contain a grounded neutral or a grounded phase conductor used as a circuit conductor in the system. The grounded neutral or grounded phase conductor is grounded at the supply transformer and will be run from the transformer bank to the meter socket and to each service disconnection means in accordance with National Electric Code® Article 250.24(B), or as may be amended.

1002.2 Ungrounded System – Customers requiring an ungrounded service for operation of a ground detection system, or for other operations permitted by the National Electric Safety Code®, shall submit an exception request detailing the special circumstances necessitating the request. In addition, the customer shall state in the exception request that he is aware of and accepts the increased risk to personal safety associated with an ungrounded service. When supplying an ungrounded service results in an additional cost to RPU, the additional cost may be passed on to the customer.

1003 SPECIAL RULES

1003.1 Customer Furnished Equipment – When a customer is furnished primary service by RPU and installs transformers or other equipment, in accordance with the applicable RPU rate schedule and Electric Service Rules & Regulations, RPU accepts no responsibility for maintaining or replacing the customer's transformers or other equipment if damaged or destroyed.

1003.2 Required Clearances – The customer shall provide a minimum of ten (10) feet of level clearance on the door side(s) of pad-mounted transformers for hot-stick operation and ten (10) feet level clearance on the door side(s) of pad-mounted primary metering cabinets for instrument transformer maintenance. Additional clearance requirements are located in Section 1200, Exhibit 7.

1004 FAULT CURRENT

1004.1 Intention – It is RPU’s intent to address the customer’s need for information concerning fault current and transformer protective device requirements pertaining to new construction, rewiring, or additional load. Refer to the current edition of the National Electric Code®, Article 110.9 Interrupting Rating and Article 110.16 Arc Flash Hazard Warning, or as may be amended.

1004.2 Tables – Tables 10.1 through 10.3 in this Section show the maximum available RMS symmetrical fault current that may be expected at the secondary terminals of distribution transformers. Each fault current value listed in the tables is based on the percent impedance value of the transformer that might be set initially or as a replacement. No primary source or secondary line impedance has been included since it is generally relatively small, may change, and cannot be accurately forecasted.

NOTE: Because an overloaded transformer is typically replaced with the next larger standard size transformer, and an under-loaded transformer may be replaced with the next smaller standard size transformer, the customer shall use this range of transformers to perform their analysis and select equipment such as fuse or circuit breakers and service entrance bus bar bracing. When selecting the fault current interrupting rating of the customer protection devices, the customer should also take into account the minimum size transformer that would be required to serve the load rating of the customer main protection device.

1004.3 Variability – Due to the variability of the transformer and electric distribution system characteristics, these tables should be used as a general guideline and shall not be used as a design tool to replace engineering that may be required by the Code Authorities having jurisdiction. Customers or contractors requiring specific fault current calculations should consult a registered professional engineer of their choice.

NOTE 1: All installations served from a single-phase pad-mount transformer should as a minimum use the calculations based on the installation of a 37.5 kVA transformer.

NOTE 2: All temporary construction meter installations may use the actual transformer size.

1005 ARC FLASH

1005.1 Intention – It is RPU’s intent to address the customer’s need for information concerning arc flash data requests as follows:

- (1) For secondary voltage services, RPU will provide upon request from the customer:

- a) Transformer size, primary voltage, secondary voltage and typical transformer percent impedance
 - b) Transformer primary fuse information and size type
 - c) Calculated symmetrical bolted three-phase fault current, bolted single-line ground fault current, and calculated system impedance (R and X) at the high side of the transformer
 - d) The upstream protective device information nearest the service point. This information will include the device model, rating and applicable settings
- (2) For primary voltage services, RPU will provide upon request from the customer:
 - (3) Calculated symmetrical bolted three-phase fault current, bolted single-line ground fault current and calculated system impedance (R and X) at the service point
 - (4) The upstream protective device information nearest the service point. This information will include the device model, rating and applicable settings

1005.2 Calculations – Fault current calculations are based upon the distribution system configuration at the time of the calculations. RPU does not provide minimum fault current information or associated protective device clearing times.

1005.3 Use of Data – It is understood that this data is to be used for arc flash calculations. Parties using this data must understand that it may change due to various reasons. RPU will not notify the customer when such changes occur.

1005.4 Table Data – Tables 10.1 through 10.3 in this Section are only intended to provide the basic information necessary for secondary service customers to make their own internal system fault current and basic arc flash calculations. Primary service customers will still need to consult with RPU's Engineering Department to obtain fault current and protective device information for their service locations.

***NOTE:** As a safety measure, RPU recommends that when customers are performing maintenance work on or near exposed electrical equipment that their electrical system be de-energized whenever possible.*

Table 10.1 Single Phase Underground

SINGLE-PHASE PADMOUNT TRANSFORMERS						
EXPECTED SINGLE-PHASE FAULT CURRENTS (IN RMS AMPS) AT THE SECONDARY TERMINALS						
					PROTECTIVE DEVICE, OVERHEAD FUSE	
TRAN	TRAN	TRAN	TRAN	Fault Current	7960V PRIMARY	
KVA	%Z	%R	%X	240V Secondary	BAY-O-NET	Amps
5	1.00	0.39	0.92	2,085	4000358C05	8
15	1.00	0.39	0.92	6,250	4000358C05	8
25	1.00	0.32	0.95	10,420	4000358C08	15
37.5	1.00	0.25	0.97	15,630	4000358C08	15
50	1.10	0.57	0.94	18,940	4000358C08	15
75	1.10	0.38	1.03	28,410	4000358C10	25
100	1.10	0.34	1.05	37,880	4000358C10	25
167	1.20	0.34	1.05	57,990	4000358C12	50
					PROTECTIVE DEVICE, OVERHEAD FUSE	
TRAN	TRAN	TRAN	TRAN	Fault Current	7960V PRIMARY	
KVA	%Z	%R	%X	480V Secondary	BAY-O-NET	Amps
15	1.1	0.39	1.03	2,840	4000358C05	8
Note: BAY-O-NET fuse is a COOPER/EATON or equivalent						

Table 10.2 Single Phase Overhead

SINGLE-PHASE OVERHEAD TRANSFORMERS										
EXPECTED SINGLE-PHASE FAULT CURRENTS (IN RMS AMPS) AT THE SECONDARY TERMINALS										
									PROTECTIVE DEVICE, OVERHEAD FUSE	
TRAN	TRAN	TRAN	TRAN	Fault Current	TRAN	TRAN	TRAN	Fault Current	7960V PRIMARY	
KVA	%Z	%R	%X	240V Secondary	%Z	%R	%X	120V Secondary	Typical	Limited Use
10	1.20	0.35	1.15	3,470	1.48	0.53	1.38	5,630	1.5X	6 ELF
15	1.20	0.66	1.00	5,210	1.56	0.99	1.20	8,010	2X	6 ELF
25	1.20	0.50	1.09	8,680	1.51	0.75	1.31	13,800	3.5X	6 ELF
37.5	1.20	0.39	1.13	13,020	1.48	0.59	1.36	21,110	5.5X	8 ELF
50	1.20	0.43	1.12	17,360	1.49	0.65	1.34	27,960	7X	12 ELF
75	1.20	0.17	1.19	26,040	1.45	0.26	1.43	43,100	10X	18 ELF
167	1.20	0.17	1.19	57,990	1.45	0.26	1.43	95,980	25KS	18 ELF

Table 10.3: Three Phase Pad-mount Transformers

THREE-PHASE PADMOUNT TRANSFORMERS									
EXPECTED THREE-PHASE FAULT CURRENTS (IN RMS AMPS) AT THE SECONDARY TERMINALS									
						TRANSFORMER PROTECTIVE DATA			
TRAN	TRAN	TRAN	TRAN	Fault Current	Fault Current	Current Limiting	Size	BAY-O-NET	Size
KVA	%Z	%R	%X	120/208V Secondary	277/480V Secondary	Cooper/Eaton or Equivalent	Amps	Cooper/Eaton or Equivalent	Amps
45	1.3	1.04	0.78	9,600	N/A	CBUC08030C100	30	4000358C05	8
75	1.3	0.7	1.10	16,000	6,900	CBUC08080C100	80	4000358C08	15
112.5	1.4	0.49	1.31	22,300	9,700	CBUC08080C100	80	4000358C08	15
150	1.4	0.35	1.36	29,700	12,900	CBUC08080C100	80	4000358C08	15
225	1.4	0.43	1.33	44,600	19,300	CBUC08100C100	100	4000358C10	25
300	1.4	0.48	1.32	59,500	25,800	CBUC08125C100	125	4000358C10	25
500	1.6	0.40	1.55	86,700	37,600	CBUC08150D100	150	4000358C12	50
750	4.5	0.39	4.48	46,300	20,000	CBUC08250D100	250	4000358C14	65
1,000	5.1	0.32	5.09	54,400	23,600	CBUC08150D100	150	4038361C03CB	135
1,500	5.1	0.36	5.09	N/A	35,400	CBUC08150D100	150	4038361C03CB	135
2,000	5.1	0.43	5.08	N/A	47,200	CBUC08165D100	165	4038361C04CB	165
2,500	5.1	0.33	5.09	N/A	59,000	CBUC08250D100	250	4038361C05CB	185

SECTION 1100 – SUPPLEMENTAL INFORMATION

1101 USE OF SERVICE

1101.1 Purpose – Electric service may be used only for the purposes set forth in the respective rate schedules. RPU is in the business of providing retail electricity to the ultimate consumer. Electricity is supplied for use by customer’s household or business, and outside sale of such service is not permitted. RPU permits redistribution and sub-metering where allowed by law, but a landlord may not charge the tenants more than the landlord is charged by RPU.

1101.2 Arrangement – The electric service equipment and associated building wiring of buildings must be arranged by the owner to facilitate individual metering of the electrical consumption of each building and occupancy unit. (Minnesota Statute Section 326B.106 Subd.12 requires separate metering on most residential units). If desired by the owner, RPU will install and maintain necessary individual RPU meters to measure consumption and tender bills on the applicable rate schedules to each customer and separately occupied buildings and occupancy units. Installation and maintenance of individual RPU meters by RPU shall not relieve the owner or landlord of responsibility for electrical service equipment and associated building wiring, nor shall it relieve the owner or landlord of responsibility to notify RPU of a single-metered residential building.

1101.3 Metering – Electric service in a single-metered residential building, as defined pursuant to Minn. Stat. 504B.215, shall be billed to the landlord/building owner except when a de minimis exception exists. A de minimis exception to the determination that a building is a single-metered residential building exists if electrical service used in a common area but measured by an individual tenant’s meter does not exceed an aggregate 1,752 kilowatt hours per year. The landlord shall bear the burden and cost associated with proving an exception. (Minnesota Statute 504B.215 Subd. 2 requires the landlord of a single-metered residential building shall be the bill payer responsible, and shall be the customer of record contracting with the utility, and requires the landlord to advise the utility of the existence of a single-metered residential building). Except where a de minimis exception applies, a single metered residential building includes the following situations: “shared meter” in which a utility meter measures service provided to a tenant’s dwelling and also measures such service to areas outside that dwelling; or “mixed wiring” in which electric outlets, fixtures or devices outside the individual unit are included on an individual meter; or “mixed plumbing” when related to electric utility service such as when an electric water heater serves more than one individual unit. RPU shall respond to a tenant customer’s request for a shared meter investigation within ten (10) business

days. RPU's investigation shall consider whether a de minimis exception applies.

1101.4 De Minimis – The following may be representative de minimis exception examples:

- (1) Common area lighting fixtures up to two (2) 100-watt light bulbs operating 24 hours/day, seven days per week
- (2) Common area outlets without constant motor loads, such as an outlet in a hallway used for housekeeping
- (3) Common area garage door opener for non-commercial use.
- (4) Mixed wiring with another tenant unit
- (5) Laundry appliances accessible by multiple tenants
- (6) Common area lighting fixtures exceeding two (2) 100-watt light bulbs operating 24 hours/day, seven days per week usage

A landlord seeking to prove a de minimis exception shall do so by providing evidence establishing by actual measurement that the usage does not exceed 1,752 kilowatt hours per year. Where such actual measurement is not possible the landlord shall present written documentation from a licensed tradesperson or housing inspector that this usage is not likely to exceed 1,752 kilowatt hours per year. Such evidence must be presented prior to, during, or within 30 days of the conclusion of a shared meter investigation.

1101.5 Adjustments – Upon discovery of a single-metered residential building, as defined pursuant to Minnesota Statute Section 504B.215, whether shared metering, mixed wiring or mixed plumbing in which individual metered service had been established and billed, RPU shall, within thirty (30) business days, recognize and make adjustments to its records to reflect that the landlord/building owner is the bill payer responsible and customer of record. RPU shall make adjustments to the tenants and landlord/building owners account based on Minnesota State Statute and RPU's standard practices. Additionally, the tenant or landlord/building owner may seek additional adjustment of charges or challenge RPU's finding of a shared meter situation by filing a complaint with the Minnesota Public Utilities Commission, or by court action. Upon request, RPU will provide to the tenant available billing history in relation to such additional actions. The Minnesota Public Utilities Commission has determined that regardless of how or by whom an investigation is initiated leading to utility account adjustments, credits and/or refunds as herein described, the investigation and any resulting adjustments, credits and/or refunds shall implicate the protections of Minnesota Statute Sections 504B.285 Subds. 2 and 3, and 504B.441.

In the event the landlord/building owner denies access to the building or fails to cooperate with an investigation to determine whether a single-metered residential building exists, as defined pursuant to Minnesota Statute Section

504B.215, the building shall be presumed to be a single-metered residential building as defined pursuant to Minnesota Statute Section 504B.215, and the landlord/building owner shall be the bill payer responsible and customer of record. RPU shall make adjustments to the tenants and landlord/building owners account based on Minnesota State Statute and RPU's standard practices. Additionally, the tenant or landlord/building owner may seek additional adjustment of charges or challenge RPU's finding of a shared meter situation by filing a complaint with the Minnesota Public Utilities Commission, or by court action. The Minnesota Public Utilities Commission has determined that regardless of how or by whom an investigation is initiated leading to utility account adjustments, credits and/or refunds as herein described, the investigation and any resulting adjustments, credits and/or refunds shall implicate the protections of Minnesota Statute Sections 504B.285 subds.2 and 3, and 504B.441.

1101.6 Service Re-establishment – In order to reestablish individual metered service for the individual tenant units, the landlord/building owner shall be required to provide certification of a licensed electrician that the building has been inspected sufficiently to determine that all instances of mixed wiring, shared metering and mixed plumbing have been eliminated or that the building qualifies for a de minimis exception, as shown by actual measurement or by certification by a licensed tradesperson or housing inspector. Additionally, the building owner may be required by RPU to post a deposit equal to the expected charges for up to two months of usage for electric service to the building.

RPU shall have the right to verify the certification at the landlord/building owner's expense prior to establishing metered service for individual units. Such verification shall not relieve the landlord/building owner of its responsibility to be the bill payer and customer of record of a single-metered residential building as defined pursuant to Minnesota Statute Section 504B.215.

1101.7 MN PUC Petition – In the event of discovery of a single-metered residential service, as defined pursuant to Minnesota Statute Section 504B.215, after previous certification to reestablish individual metered service for tenants, in addition to the above adjustments, the building shall be ineligible for individual metered service for tenants without petition to the Minnesota Public Utilities Commission by the landlord/building owner and a showing by the building owner by clear and convincing evidence justifying the reestablishment of individual metered service for tenants. Additionally, the MPUC may require consent of the building's tenants in determining that reestablishment of the individual metered service for tenants is appropriate.

1101.8 Series Metering – RPU will not install, operate, maintain, or acquire any series metering system. RPU may, however, require series subtractive

metering for its own purposes to measure consumption and render bills for electric energy not otherwise measured.

1101.9 Service Arrangement – Electricity is normally supplied to each separate customer through a single service and meter. RPU does not engage in the practice of doing interior wiring on customer's premises except for the installation and maintenance of its own property. The customer may combine the supply of electricity through one meter and one service to two or more buildings or occupancy units if they are located on the same or contiguous parcels of property and occupied by the same customer, solely for customer's own use. If separate buildings are occupied in whole or part by tenants of the customer, then each tenant occupied building, or area, or occupancy unit must be segregated from other loads of the customer and metered by RPU.

1101.10 Legacy Arrangement – If more than one building with tenants, or portions of more than one building with tenants, are served through one meter, this practice may continue until such time as material structural changes are made that will result in major modifications to the customer's service entrance equipment. If such modifications do occur, provisions must be made to allow for individual RPU metering of each tenant occupied building, or area, or occupancy unit. While the single meter service continues, the bill for the buildings will be computed as though each building used an equal portion of the total metered service and was separately billed.

1101.11 Customer Responsibility – All wiring and equipment on customer's side of the point of delivery, except metering equipment, will be furnished, installed, and maintained at the customer's expense in a manner approved by the public authorities having jurisdiction over the same. Customer will protect all electrical equipment and systems with devices that conform to the industry accepted standard for the various classes of electrical equipment and systems to prevent fire or damage to equipment from electrical disturbances or fault occurring in the customer's system or in the supplying system. The "industry accepted standard" will be as required in the National Electrical Code and such additional devices as are prescribed by any public authority with jurisdiction over the installation of electrical facilities.

1101.12 Inspections – Any inspection of a customer's wiring and equipment by RPU is for the purpose of avoiding unnecessary interruptions of service to its customers or damage to its property, and for no other purpose, and will not be construed to impose any liability upon RPU to a customer or any other person by reason thereof. In addition, RPU will not be liable or responsible for any loss, injury, or damage that may result from the use of or defects in a customer's wiring or equipment.

RPU may, however, at any time require a customer to make such changes in customer's electrical or non-electrical property or use thereof as may be necessary to eliminate any hazardous condition or any adverse effect which the operation of the customer's property or equipment may have on said customer, other customers of RPU, the public, or RPU's employees, equipment or service. In lieu of changes by the customer, RPU may require reimbursement from the customer for the cost incurred by RPU in alleviating an adverse effect on RPU's facilities caused by the customer's property.

1101.13 Capacity – The transformers, service conductors, meters, and appurtenances used in furnishing electric service to a customer have a definite capacity. Therefore, no material increase in load or equipment will be made without first making arrangements with RPU for the additional electric supply.

1102 RATE SCHEDULE CLASSIFICATION

Electric service is supplied to customers under various rate schedule classifications as determined by the type of service, the amount of electric power supplied, and the purpose for which the electric service is to be used. Copies of RPU's rate schedules are available at RPU's Service Center and <https://www.rpu.org/my-account/rates-fees.php>.

1103 PAYMENT

1103.1 Meter Reading – RPU will, insofar as possible, read all meters every month and bill the customer for service used during the period. Payment of the bill is due by the date noted on the bill.

1103.2 Estimated Billing – If the meter cannot be read during a billing period, or the reading seems erroneous, an estimate will be made for that billing period. Adjustments to bills resulting from inaccuracies in the meters will be handled in the manner described in Section 608, Meter Testing.

1104 CUSTOMER CHARGE

There is a customer charge for each meter/service provided. The amount of this customer charge will vary based on the type and number of services provided (refer to RPU's rate schedule(s) for more information).

1105 NEW UNDERGROUND RESIDENTIAL SERVICE CONNECTION CHARGE

1105.1 Charges – RPU will charge an underground service connection charge (New Underground Service fee) for the extension and/or connection of new underground electrical service to any single-family home, townhome, condominium, duplex or triplex located in a R-1, R-1x, R-Sa, R-2, R-4 or Special District, zoning districts. The amount of the charge can be obtained from a Customer Care Advisor.

1105.2 Service Connections – There will be no charge for connections or reconnections of existing services, in good payment standing, during RPU's normal working hours. If connection must be made outside of normal working hours at the request of the customer, a special connection charge will be assessed. The charge for such work can be obtained from a Customer Care Advisor.

1106 SERVICE DISCONNECTION/RECONNECTION

1106.1 With Notice – RPU may disconnect a customer's service, with notice, for any of the following reasons:

- (1) Nonpayment of billings or issuance of non-negotiable check
- (2) Nonpayment of a deposit or other charges/fees
- (3) Failure to meet credit requirements
- (4) Failure to provide access to RPU owned metering equipment

1106.2 Without Notice – RPU may disconnect a customer's service, without notice, for any of the following reasons:

- (1) A condition determined to be hazardous – to the customer, to other customers, or to RPU personnel
- (2) Unauthorized use of electricity, water, or equipment belonging to RPU

1106.3 Reconnection Fee – In the event service has been disconnected for nonpayment, deposit, theft, or other credit cause, the customer will be required to pay a reconnection fee before the service is restored. In the event that the service is disconnected because of hazardous conditions on the customer owned equipment or unauthorized use, the customer will be required to have all required inspections performed prior to service being restored.

1106.4 Fee Schedule – A schedule of fees is available from an RPU Customer Care Advisor.

1107 SERVICE DEPOSIT

RPU has established a credit policy whereby existing customers with an acceptable credit history and customers never having had service with RPU may not be required to provide a deposit as a condition of service. A new or additional deposit may be required in cases where a deposit has been refunded or where the current deposit amount is inadequate. The deposit amount is based on two times the average monthly bill and bears interest at the rate established by Minnesota Statute Section 325E.02. Further information is available in the RPU Deposit Policy.

1108 POWER FACTOR CORRECTION CALCULATION

Refer to Table 11.1 on the following page for instructions for multipliers to determine required capacitor kVARs for correcting power factor.

TABLE 11.1 – POWER FACTOR CORRECTION CALCULATION TABLE

ORIGINAL POWER FACTOR	CORRECTED POWER FACTOR						
	90%	92%	94%	95%	96%	98%	100%
60%	0.849	0.907	0.970	1.005	1.042	1.130	1.333
62%	0.781	0.839	0.903	0.937	0.974	1.062	1.265
64%	0.716	0.775	0.838	0.872	0.909	0.998	1.201
66%	0.654	0.712	0.775	0.81	0.847	0.935	1.138
68%	0.594	0.652	0.715	0.750	0.787	0.875	1.078
70%	0.536	0.594	0.657	0.692	0.729	0.817	1.020
72%	0.480	0.538	0.601	0.635	0.672	0.761	0.964
74%	0.425	0.483	0.546	0.580	0.617	0.706	0.909
76%	0.371	0.429	0.492	0.526	0.563	0.652	0.855
78%	0.318	0.376	0.439	0.474	0.511	0.599	0.802
80%	0.266	0.324	0.387	0.421	0.458	0.547	0.750
82%	0.214	0.272	0.335	0.369	0.406	0.495	0.698
84%	0.162	0.220	0.283	0.317	0.354	0.443	0.646
86%	0.109	0.167	0.230	0.265	0.302	0.390	0.593
88%	0.055	0.114	0.177	0.211	0.248	0.337	0.540
90%	0	0.058	0.121	0.156	0.193	0.281	0.484
92%		0	0.063	0.097	0.134	0.223	0.426
94%			0	0.034	0.071	0.160	0.363
96%					0	0.089	0.292
98%						0	0.203
100%							0

INSTRUCTIONS:

1. Determine the average power factor that your system operates at during peak demand months. Call this your ORIGINAL POWER FACTOR.
2. In the row titled CORRECTED POWER FACTOR at the top of the page, find the power factor that you wish to correct your system to.
3. Read from left to right along the row corresponding to your ORIGINAL POWER FACTOR until you reach the column that shows your desired CORRECTED POWER FACTOR.
4. Read the number that you find at the intersection of the row and column. Multiply your KW Demand by this number to calculate the total amount of capacitor KVAR you need to install to your electric service.
5. If your plant operates with a 3 phase electric service, divide the total KVAR by 3 to determine the amount of KVAR to connect per phase.

Example: If your plant has a 3 phase demand of 410 KW and operates at 76% power factor, but you want to correct to 95%:

- a) Find 95% in the CORRECTED POWER FACTOR row at the top of the page
- b) Find 76% in the ORIGINAL POWER FACTOR column along the left edge of the page. Read from left to right along this row until you reach the 95% column
- c) Read the number at the intersection of the row and column (0.526)
 $410 \text{ KW} \times 0.526 = 216 \text{ KVAR}$ needed to correct your system to 95% power factor
- d) $216 \div 3 = 72 \text{ KVAR}$ per phase

SECTION 1200 – EXHIBIT DRAWINGS & INFORMATION

EXHIBIT

- 1 Typical Underground Residential Metering Arrangement
- 2 Typical **Free Standing Meter Structure**
- 3 Typical Multiple Metering Arrangement
- 4 Service Conductor Clearances (480V and below)
 - 4.1 Service Conductor Clearances from Balconies & Windows
 - 4.2 Secondary Conductor Clearances over Roofs
 - 4.3 Service Conductor Clearances to Patios and Pools
 - 4.4 Service Conductor Clearances to Aboveground Swimming Pool With Deck
 - 4.5 Service Conductor Clearances to Aboveground Swimming Pool Without Deck
- 5 Overhead Supply Secondary Temporary Service Installation
- 6 Typical Residential Service Mast Installation with Guying
 - 6.1 Typical Residential Under Eaves Service Installation
- 7 Clearance Requirements of Pad-Mounted Transformers
 - 7.1 Transformer Bollard Detail
- 8 RPU and Customer Responsibilities Associated with Non-Single Family Underground Installations
- 9 RPU and Customer Responsibilities Associated with Underground Single Family Residential Distribution (URD) Installations
- 10 Installation Guidelines
- 11 Meter Socket Types
 - 11.1 Required Meter Working and Safety Clearances

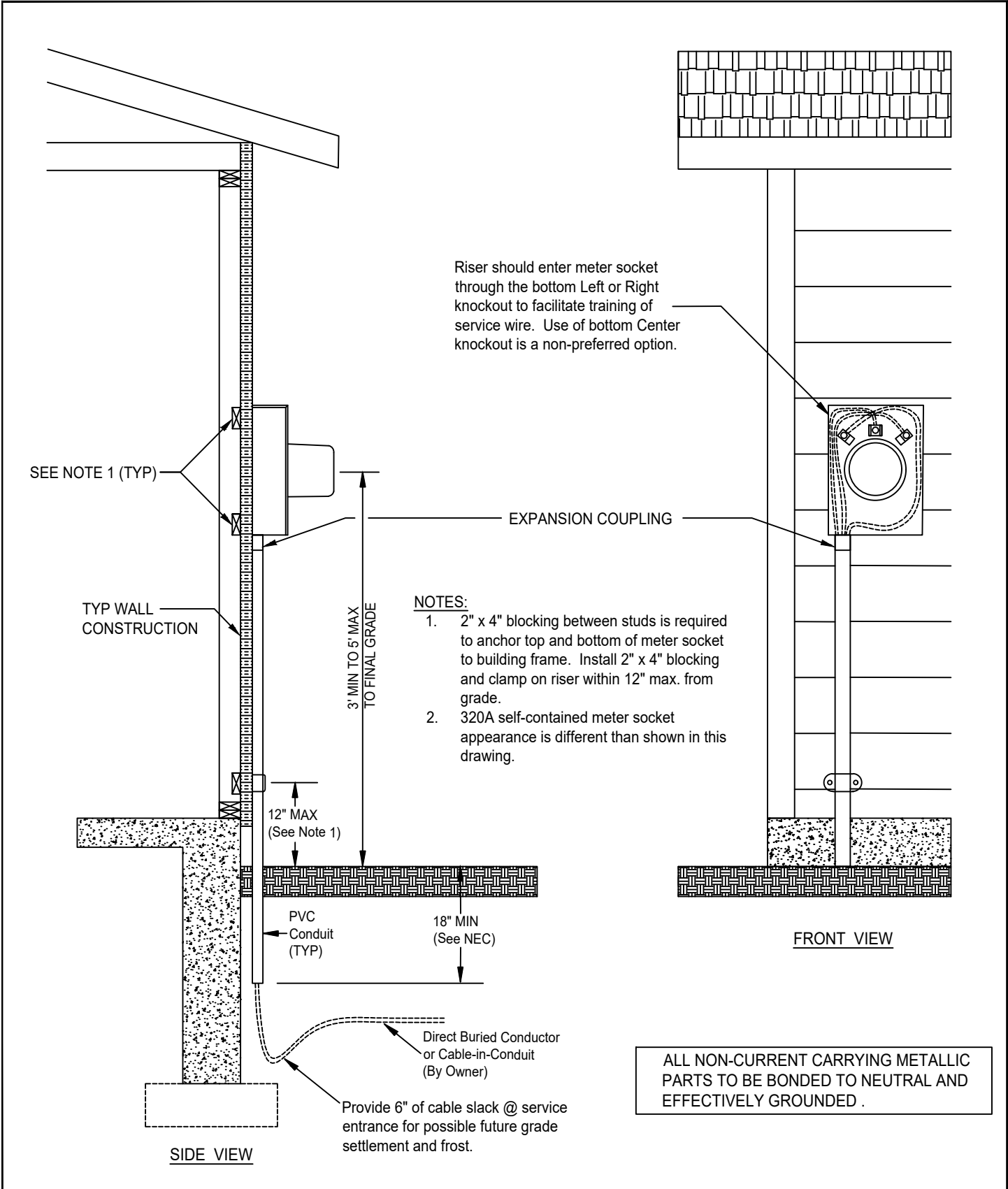

ROCHESTER PUBLIC UTILITIES

NO	REVISION	BY	DATE
0	ORIGINAL DRAWING	BJK	05/01/2017
1	ADJUSTED EXPANSION COUPLING	BJK	02/08/2021

TYPICAL RESIDENTIAL UNDERGROUND SERVICE METER INSTALLATION

EXHIBIT
1

PREFERRED INSTALLATION

Point of delivery at line side of meter on residential service.
 Minimum 3/4" exterior plywood suitably finished for weather resistance or suitable Unistrut

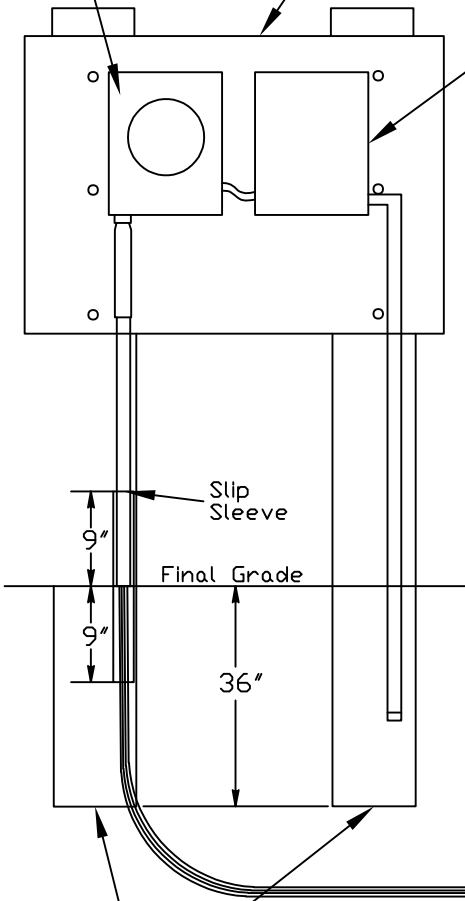

2-6"x6" treated wood posts or
 2-4" GRC posts
 2-Suitable Unistrut

ALTERNATIVE SINGLE POST INSTALLATION

Service equipment furnished and installed by customer.

Lever operated by-pass required on all meter sockets.

The neutral wire from the 5th terminal on single-phase and the 7th terminal on 3-phase, 4-wire shall be connected to neutral within meter socket.

RESIDENTIAL

200 Amp Service-2" minimum meter riser installed by customer.
 320 Amp Service-3" minimum meter riser installed by customer.
 Schedule 80 PVC (UL category DZXR) or galvanized rigid conduit.

COMMERCIAL

Service riser sized per NEC.

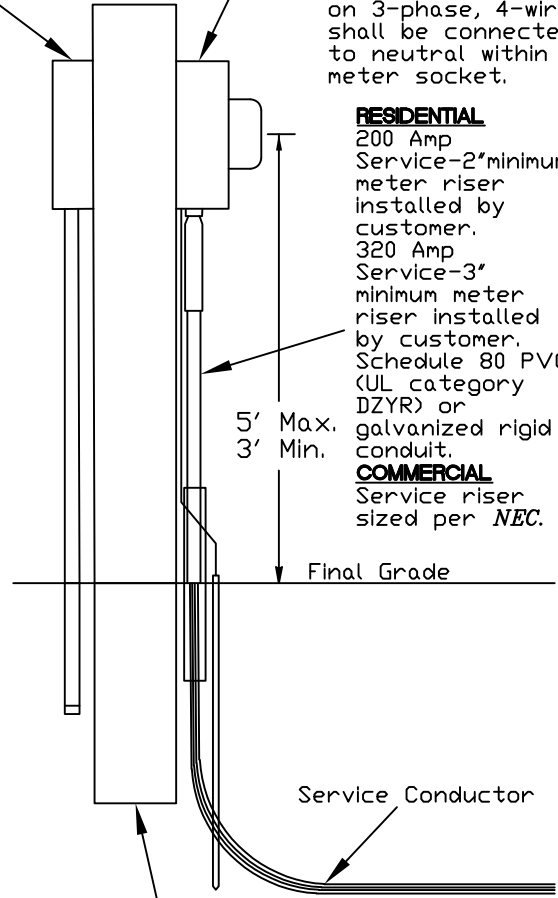

Post Depth 36" minimum

ROCHESTER PUBLIC UTILITIES

REVISION	BY	DATE
ORIGINAL DRAWING	BJK	12/2023

TYPICAL FREE STANDING METER STRUCTURE

EXHIBIT 2

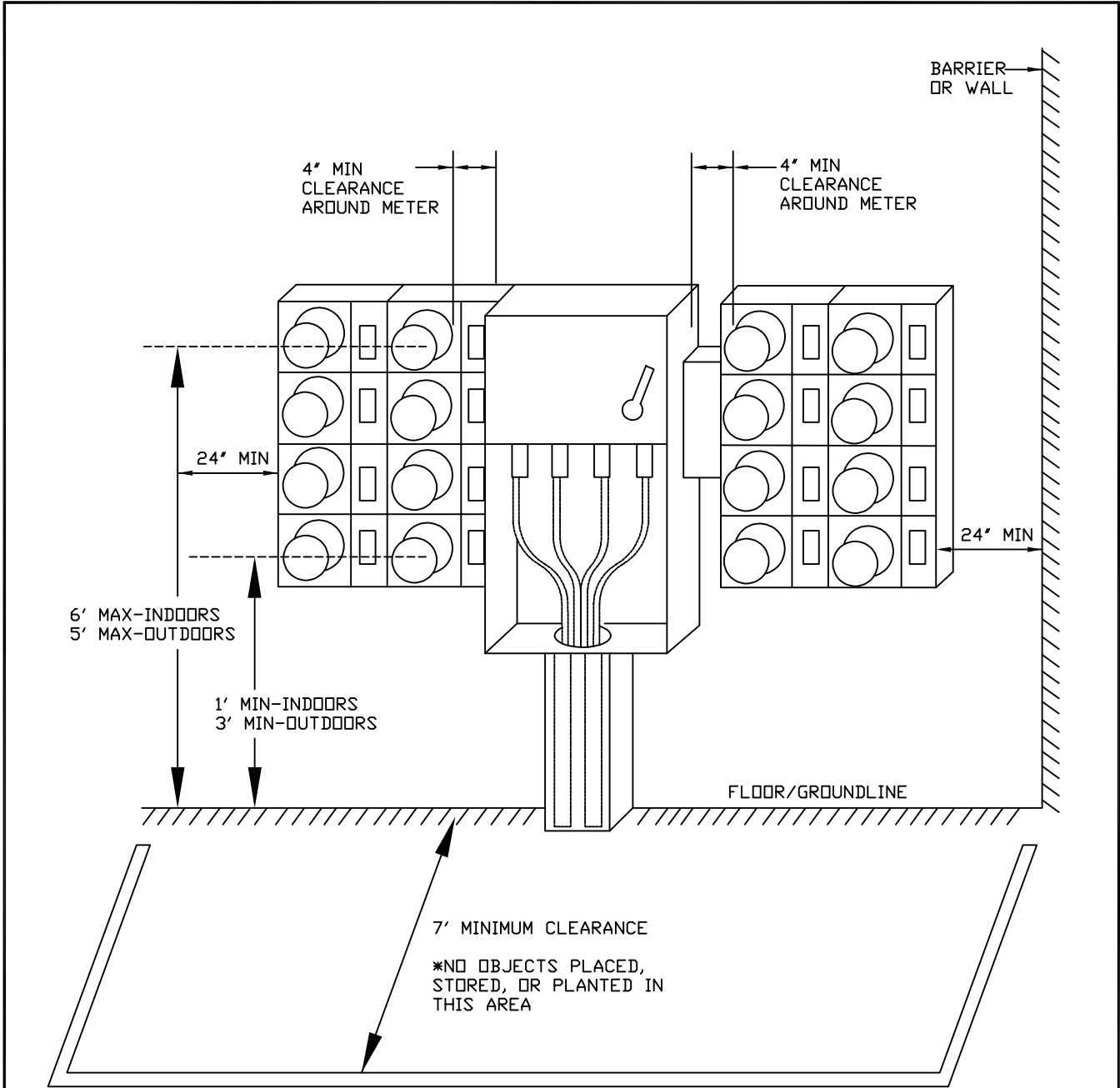

NOTES:

- Indoor meter locations shall not be hazardous or cause inconvenience to employees of RPU when installing, maintaining, or reading the meters. RPU personnel shall have direct and unobstructed access to RPU's metering equipment at all times.

NOT TO SCALE

ROCHESTER PUBLIC UTILITIES

NO	REVISION	APPROVED BY	DATE
0	ORIGINAL DRAWING CREATED	JSA	9/23
1	TEXT UPDATES	JSA	12/23

TYPICAL MULTIPLE METERING ARRANGEMENT

EXHIBIT 3

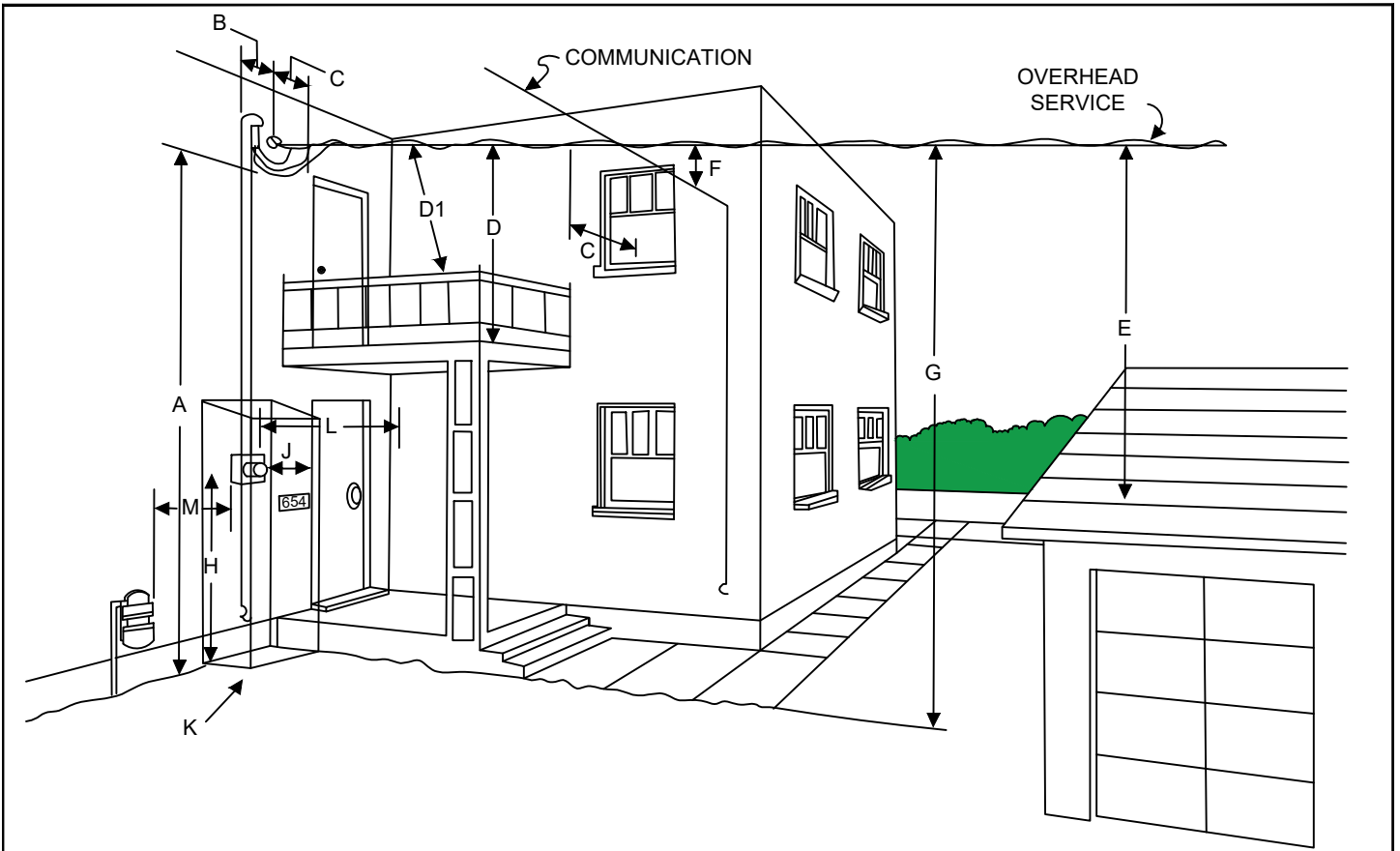

The general clearances listed on the next page, under any and all conditions, include Rochester Public Utilities' requirements and interpretations derived from the NESC Rule 234 and the NEC Section 230.24. Refer to those Sections for specific conditions not depicted. Clearances for utility-owned service drops and cables, beyond the perimeter of the customer's buildings, will be controlled by the NESC requirements. The alphabetical designations and respective dimensions on the next page apply to the illustration above. Clearances shown are for multiplex (duplex, triplex, and quadruplex) service drop conductors only - open wire service conductors require greater clearance.

ROCHESTER PUBLIC UTILITIES

NO	REVISION	BY	DATE
0	ORIGINAL DRAWING	BJK	05/01/2017
1	ADDED CLEARANCE CONDITION D1	BJK	02/08/2021

SERVICE CONDUCTOR CLEARANCES (480V AND BELOW)

EXHIBIT
4

CLEARANCE CONDITION:

- A- The drip loop or service attachment fixture, whichever is the lowest point, shall have 12 feet minimum vertical clearance above final grade. Higher clearances may be required, reference "G" below.
- B- The clearance between the service attachment and weatherhead shall be 12 inches minimum and 24 inches maximum.
- C- Service conductors that are not protected by conduit or raceway shall have a minimum clearance of 3 feet from windows designed to be opened, doors, porches, fire escapes, signs, and similar construction. Conductors run above the top level of a window shall be permitted to be less than the 3 feet requirement.
- D- The diagonal distance from the nearest edge of a balcony or deck handrail that is readily accessible to the service conductor shall be 10 feet minimum.
- D1- 3.5 feet
- E- The minimum vertical clearance shall be:
3.5 feet for roof slope not readily accessible to pedestrians
11.0 feet for roof slope readily accessible to pedestrians
- F- Minimum vertical clearances between service drop and communication conductors shall be 2 feet at the conductor crossing and 12 inches at adjacent vertically spaced attachments to the building.
- G- The minimum vertical clearance shall be:
12 feet above sidewalk and ground
16 feet above residential driveways
18 feet above commercial areas, public driveways, alleys and streets, and other land traversed by vehicles
20 feet above Department of Transportation right of way and others as required by local jurisdiction
- H- For individual settings, the clearance between the center of the meter and the finished grade is to be 5 feet maximum and 3 feet minimum.
- J- The dimension between the hinged side of a door and the nearest surface of the meter is to be door width plus 6 inches.
- K- A clear working space, as shown by the box in the diagram, of not less than 36 inches in front of the meter and 30 inches wide shall be maintained at all times. (*NEC* Section 110.26)
- L- The horizontal clearance from the nearest side of the meter socket enclosure to any structural protrusion shall be 3 inches minimum.
- M- Horizontal distance of electric meter to gas regulator vent is 3 feet minimum.

ROCHESTER PUBLIC UTILITIES

NO	REVISION	BY	DATE
0	ORIGINAL DRAWING	B.R.K	05/01/2017
1	ADDED CLEARANCE CONDITION D1	B.R.K	02/08/2021

SERVICE CONDUCTOR CLEARANCES (480V AND BELOW)

EXHIBIT
4
(Continued)

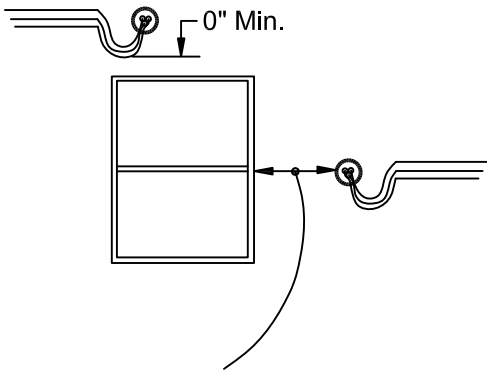

NESC 234-1: A horizontal clearance of not less than 3' for triplex and 5'-6" for open wire must be maintained from window. Above window a 0" vertical clearance is allowed.

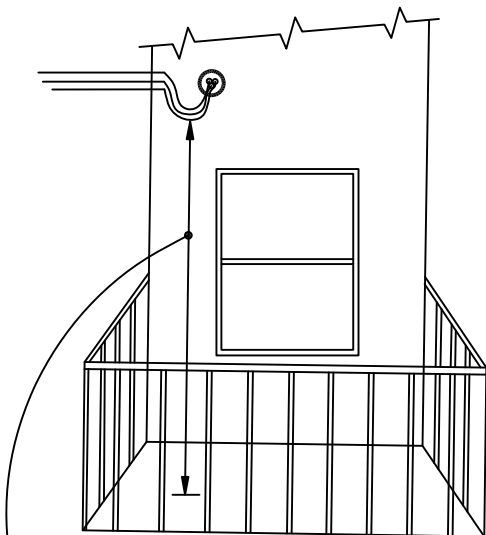

NESC 234-1: Open wire up to 750 volts to ground = 11'-6"
 Open wire over 750 volts to ground = 13'-6"
 Triplex/quadruplex = 11'-0".

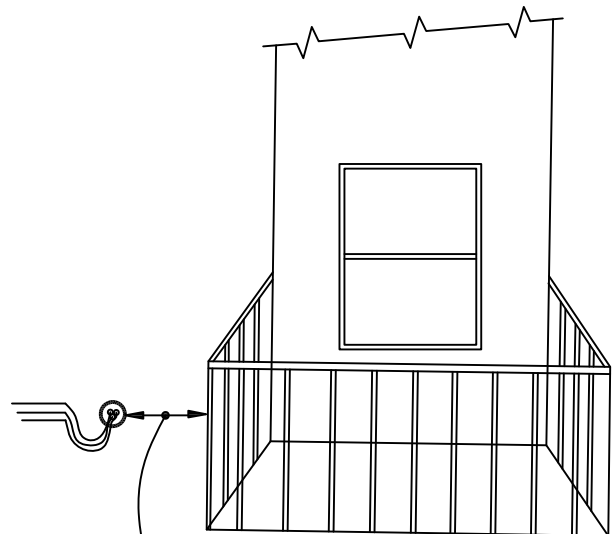

NESC 234-1: Conductors shall have a horizontal clearance of 3' for triplex and 5'-6" for open wire.

ROCHESTER PUBLIC UTILITIES

NO	REVISION	BY	DATE
0	ORIGINAL DRAWING	BJK	05/01/2017

SERVICE CONDUCTOR CLEARANCES FROM WINDOWS AND BALCONIES

EXHIBIT 4.1

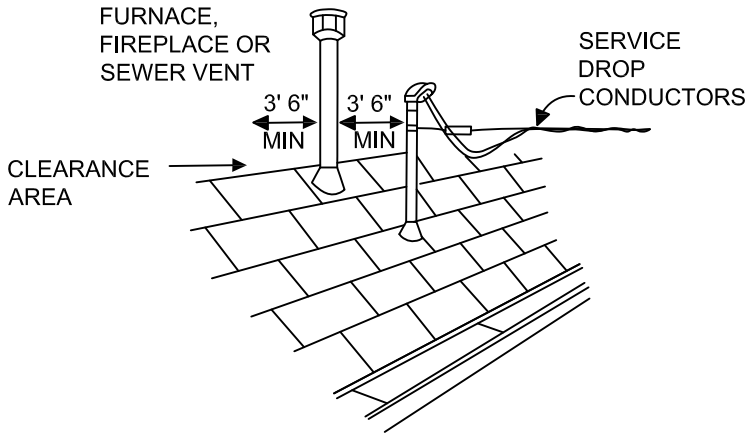

FIG. 1

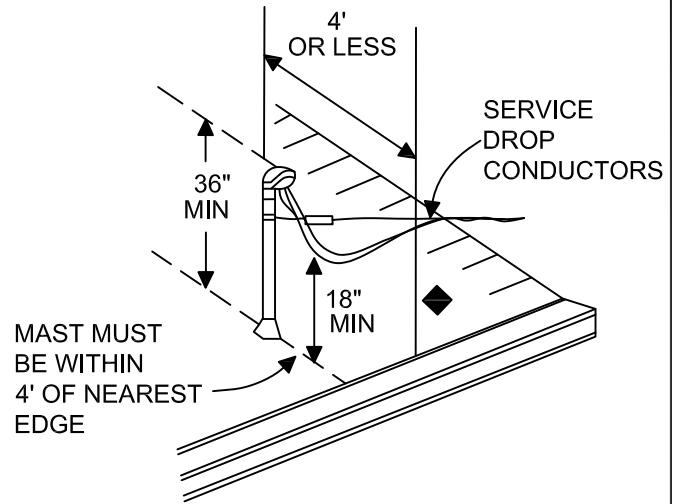

FIG. 2

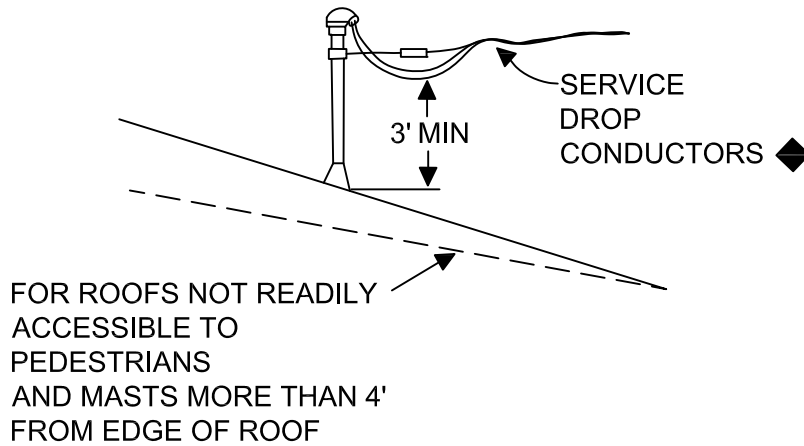

FIG. 3

◆ THIS VERTICAL DIMENSION APPLIES TO ANY POINT ON THE ROOF SURFACE DIRECTLY UNDER THE CONDUCTORS.

ROCHESTER PUBLIC UTILITIES

NO	REVISION	BY	DATE
0	ORIGINAL DRAWING	BJK	05/01/2017

SERVICE CONDUCTOR CLEARANCES OVER ROOFS

EXHIBIT 4.2

Type of Structure Under or Next to Wire	Neutrals, Guys, Messengers; Surge protection; Wires and Communications	Duplex, Triplex, Quadraplex, Lashed 0 - 750 V	Open Supply Conductors 0 - 750 V	Primary Conductors 750 V - 22 kV
Clearance In Any Direction To: Edge of pool, water surface, Base of diving platform or anchored raft. (Dimension A)	22' - 0" (Note 1)	22' - 6" (Note 1)	23' - 0"	25' - 0"
Clearance In Any Direction To: Diving platform or Tower (Dimension B)	14' - 0" (Note 6)	14' - 6" (Note 6)	15' - 0" (Note 6)	17' - 0" (Note 6)
Hot Tubs and Whirlpool Spas: (Notes 4 and 5)	10' - 6"	11' - 0"	11' - 6"	13' - 6"

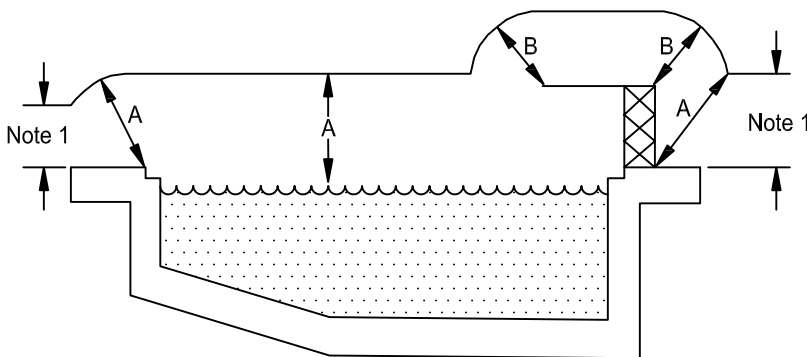

Clearances of Underground Secondary Service Lateral to Patios and Pools

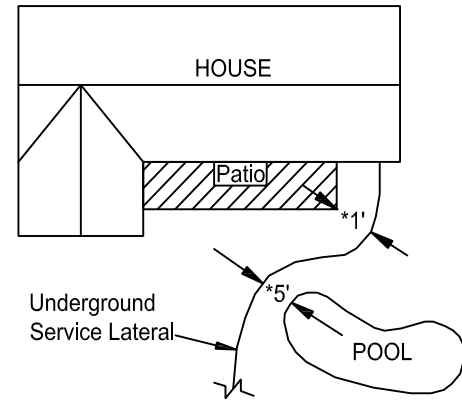

*These dimensions are minimum unless cable is in conduit

NOTES:

- 0 - 750 volts except open wire HORIZONTALLY greater than 10 feet from the edge of the pool or diving platform NEEDS ONLY a vertical clearance of 12.5 feet in pedestrian only traffic areas.
- Table data is for below grade pool (as depicted).
- Values are from NESC Table 234-3.
- For hot tubs and whirlpool spas, clearance is the same as clearance from balconies, decks and areas accessible to pedestrians. Clearance would be from the highest point a person could stand to the conductor.
- For hot tubs and whirlpool spas, clearance is less than swimming pools since long handled cleaning equipment and rescue poles are not used.
- For horizontal clearance, add 2 feet for conductor swing.

ROCHESTER PUBLIC UTILITIES

NO	REVISION	BY	DATE
0	ORIGINAL DRAWING	BJK	05/01/2017

SERVICE CONDUCTOR CLEARANCES TO PATIOS AND POOLS

EXHIBIT 4.3

Type of Structure Under or Next to Wire	Neutrals, Guys, Messengers; Surge protection; Wires and Communications	Duplex, Triplex, Quadraplex, Lashed 0 - 750 V	Open Supply Conductors 0 - 750 V	Primary Conductors 750 V - 22 kV
Clearance In Any Direction To: Edge of pool, water surface, Base of diving platform or anchored raft. (Dimension A)	22' - 0"	22' - 6"	23' - 0"	25' - 0"
Hot Tubs and Whirlpool Spas: (Notes 2 and 3)	10' - 6"	11' - 0"	11' - 6"	13' - 6"

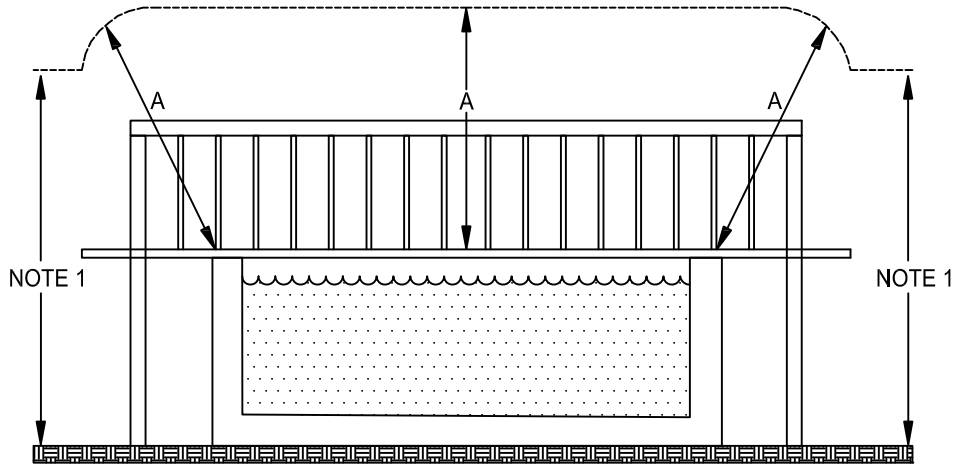

ABOVEGROUND SWIMMING POOL WITH DECK.
CLEARANCE IS MAINTAINED FROM THE
HIGHEST POINT OF THE INSTALLATION UPON
WHICH PEOPLE CAN STAND.

NOTES:

1. 0 - 750 volts except open wire HORIZONTALLY greater than 10 feet from the edge of the pool NEEDS ONLY a vertical clearance of 12.5 feet in pedestrian only traffic areas.
2. For hot tubs and whirlpool spas, clearance is the same as clearance from balconies, decks and areas accessible to pedestrians. Clearance would be from the highest point a person could stand to the conductor.
3. For hot tubs and whirlpool spas, clearance is less than swimming pools since long handled cleaning equipment and rescue poles are not used.

ROCHESTER PUBLIC UTILITIES

NO	REVISION	BY	DATE
0	ORIGINAL DRAWING	BJK	05/01/2017

SERVICE CONDUCTOR CLEARANCES
TO ABOVEGROUND SWIMMING POOL
WITH DECK

EXHIBIT
4.4

Type of Structure Under or Next to Wire	Neutrals, Guys, Messengers; Surge protection; Wires and Communications	Duplex, Triplex, Quadraplex, Lashed 0 - 750 V	Open Supply Conductors 0 - 750 V	Primary Conductors 750 V - 22 kV
<u>Clearance In Any Direction To:</u> Edge of pool, water surface, Base of diving platform or anchored raft. (Dimension A)	22' - 0"	22' - 6"	23' - 0"	25' - 0"
<u>Hot Tubs and Whirlpool Spas:</u> (Notes 2 and 3)	10' - 6"	11' - 0"	11' - 6"	13' - 6"

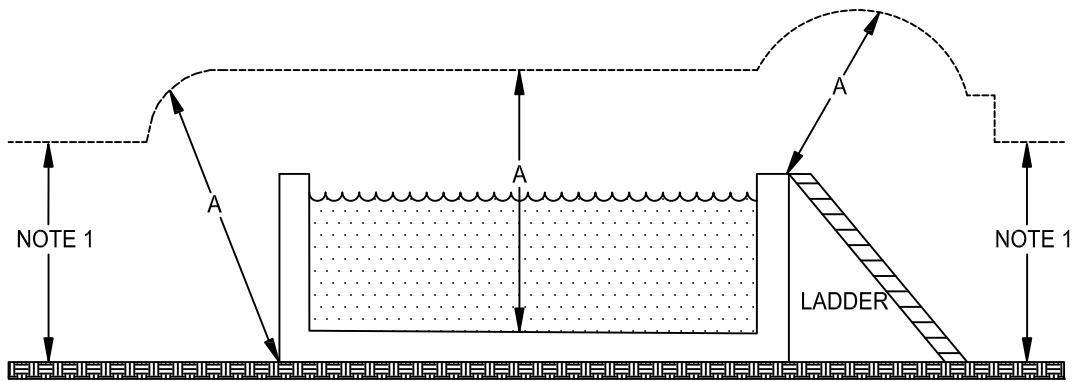

ABOVEGROUND SWIMMING POOL WITHOUT DECK. REQUIRED CLEARANCE IS MAINTAINED ABOVE GROUND.

NOTES:

- 0 - 750 volts except open wire HORIZONTALLY greater than 10 feet from the edge of the pool NEEDS ONLY a vertical clearance of 12.5 feet in pedestrian only traffic areas.
- For hot tubs and whirlpool spas, clearance is the same as clearance from balconies, decks and areas accessible to pedestrians. Clearance would be from the highest point a person could stand to the conductor.
- For hot tubs and whirlpool spas, clearance is less than swimming pools since long handled cleaning equipment and rescue poles are not used.

ROCHESTER PUBLIC UTILITIES

NO	REVISION	BY	DATE
0	ORIGINAL DRAWING	BJK	05/01/2017

SERVICE CONDUCTOR CLEARANCES TO ABOVEGROUND SWIMMING POOL WITHOUT DECK

EXHIBIT 4.5

Installation shall be outside the utility easement and located no closer than 10' minimum or 70' maximum with a conductor no larger than 4/0 from RPU's secondary supply point.

6' x 6' post or pole furnished, installed and owned by customer.
 Utility pole designation = Class 7 Minimum or Class 6
 Pole Height = 25' Minimum
 Pole Strength = 1200 ft-lb, minimum 5'-6" embedded
 Circumference = At ground line 23.5', at pole top 15'
 Pole must be treated to prevent ground line decay

A 5 terminal and lever-type bypass is required on all 1-phase services. 7 terminal lever-type bypass is required on all 3-phase, 4-wire services (320A maximum).

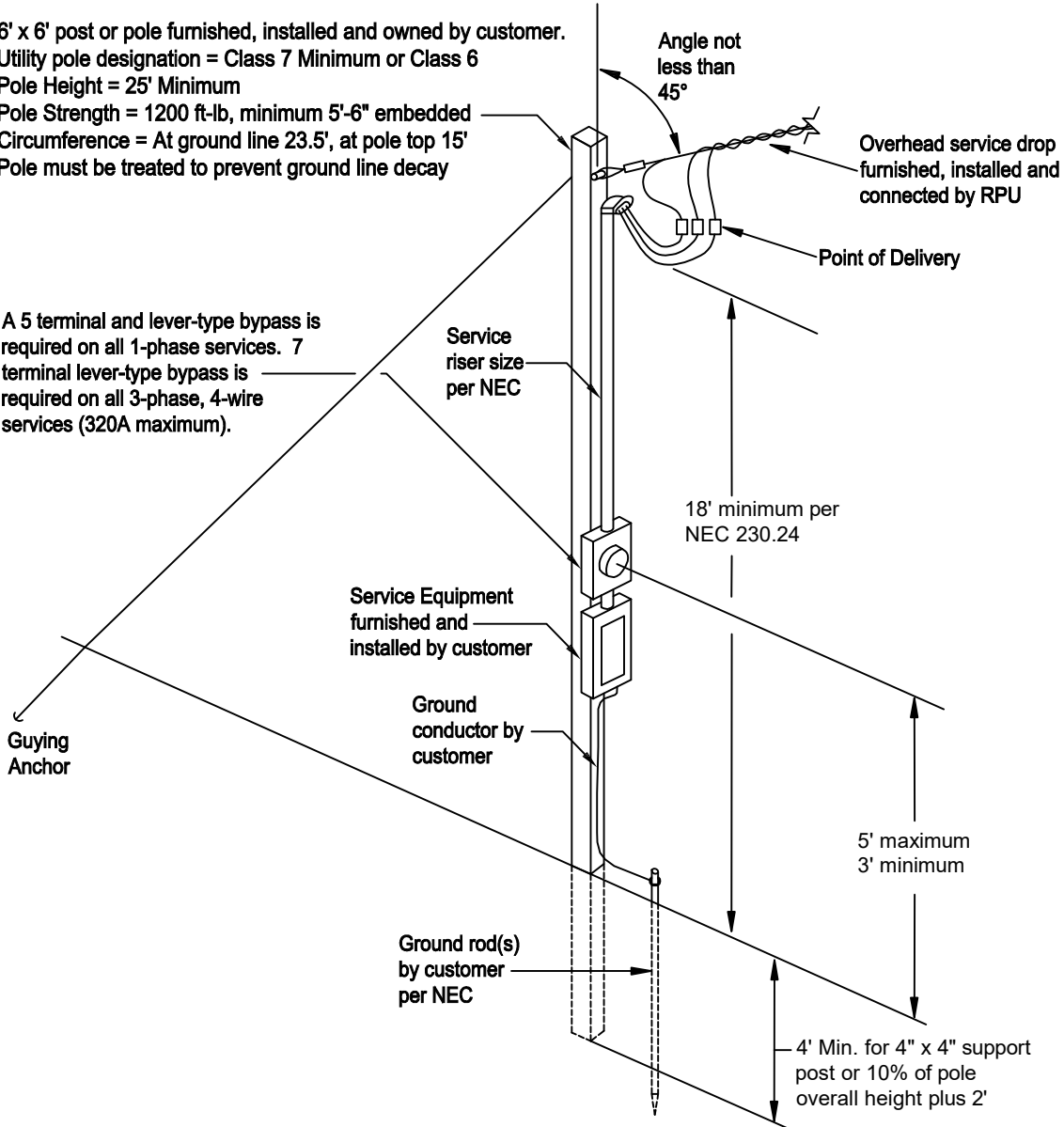

NOTES:

1. Temporary installation shall not be attached to a RPU-owned pole.
2. Support may require additional braces to be protected from vehicular and other construction hazards.
3. Make sure area is clear of underground obstructions before installing support or ground rod.
4. Service drop shall not be at an angle of less than 45° from vertical.

ROCHESTER PUBLIC UTILITIES

NO	REVISION	BY	DATE
0	ORIGINAL DRAWING	BJK	05/01/2017

OVERHEAD SUPPLY SECONDARY TEMPORARY SERVICE INSTALLATION

**EXHIBIT
5**

NOTE:

Service mast must be mounted on side nearest distribution pole or near rear corner if clear path exists between service attachment & pole. Avoid service wire overhang over roof, or provide clearance required over roof. Service entrance must be rigidly secured.

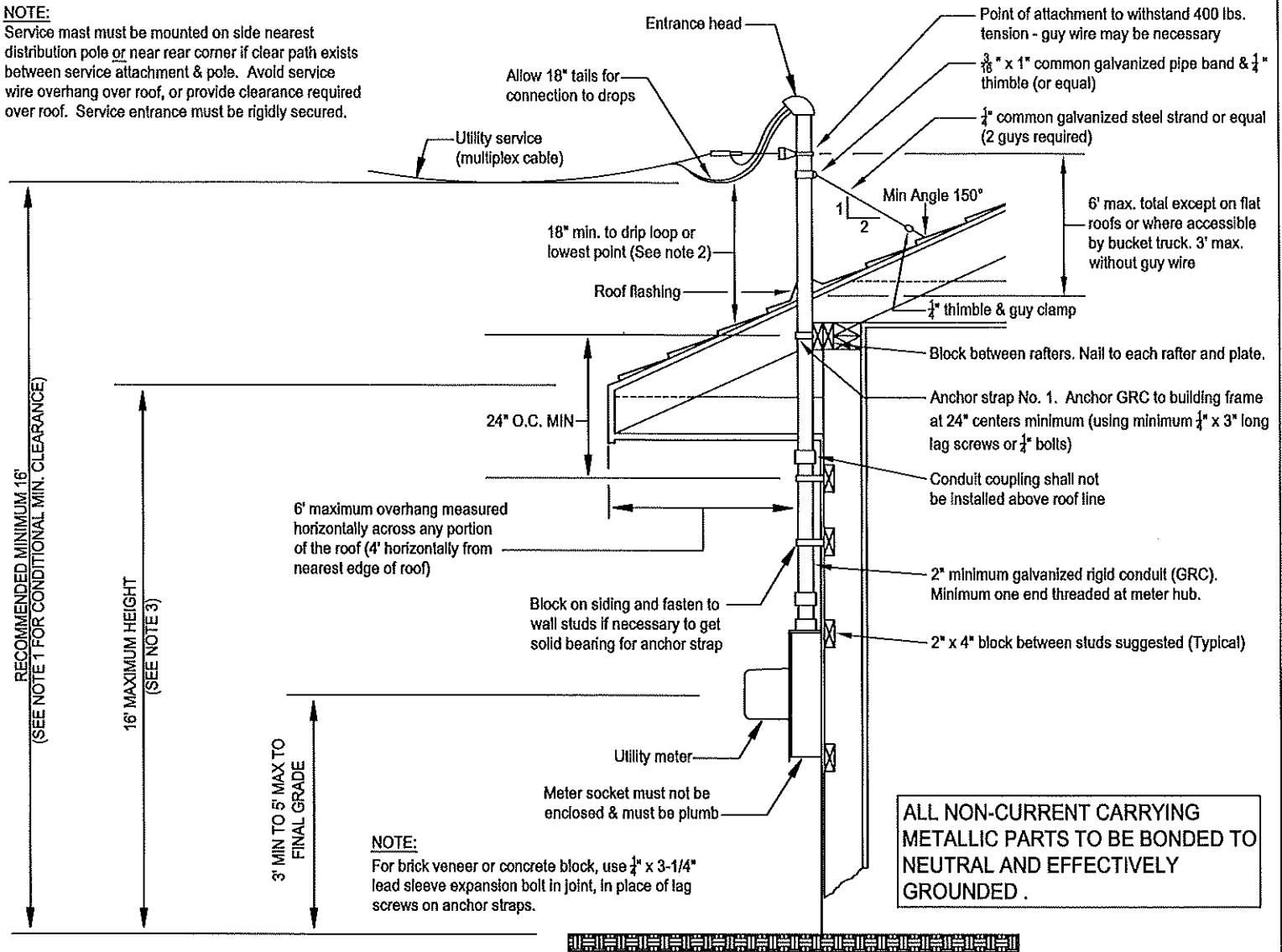

ALL NON-CURRENT CARRYING METALLIC PARTS TO BE BONDED TO NEUTRAL AND EFFECTIVELY GROUNDED.

NOTE:
For brick veneer or concrete block, use 1/4" x 3-1/4" lead sleeve expansion bolt in joint, in place of lag screws on anchor straps.

NOTES:

1. If the land under the cable is accessible to truck traffic or to vehicles over 8 feet in height, the minimum attachment height is 16 feet. If the area is subject to pedestrian or restricted traffic only (no vehicles over 8 feet in height), the minimum attachment height is 12 feet; refer to NESC Table 232-1.
2. If the service is crossing the roof for more than 6 feet horizontally in any direction, or more than 4 feet horizontally from the nearest edge of the roof, refer to NESC 234C3 for the appropriate clearance.
3. The service access point (roof edge, etc.) shall not exceed 16 foot height above grade, unless accessible by bucket truck.

3/8" eye bolts & washers with header block are acceptable, but eye lags are not. As an alternate, one guy aligned with the service wire and adequately attached to a 3/8" eye bolt (not lag) through a header block between rafters is acceptable.

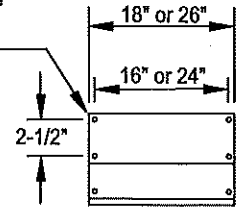

ROOF PLATE (OR EQUAL)

Roof plate must be installed so that service alignment extension falls within angle of guys

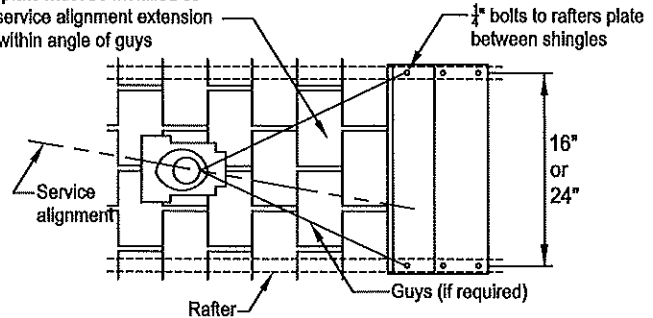

GUY DETAIL

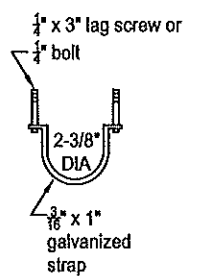

ANCHOR STRAP No. 1 (OR EQUAL)

*NOT TO SCALE

ROCHESTER PUBLIC UTILITIES

NO	REVISION	BY	DATE
0	ORIGINAL DRAWING	BJK	05/11/2017
1	MISC. TEXT CHANGES	JA	02/09/2024

TYPICAL RESIDENTIAL SERVICE MAST INSTALLATION WITH GUYING

EXHIBIT 6

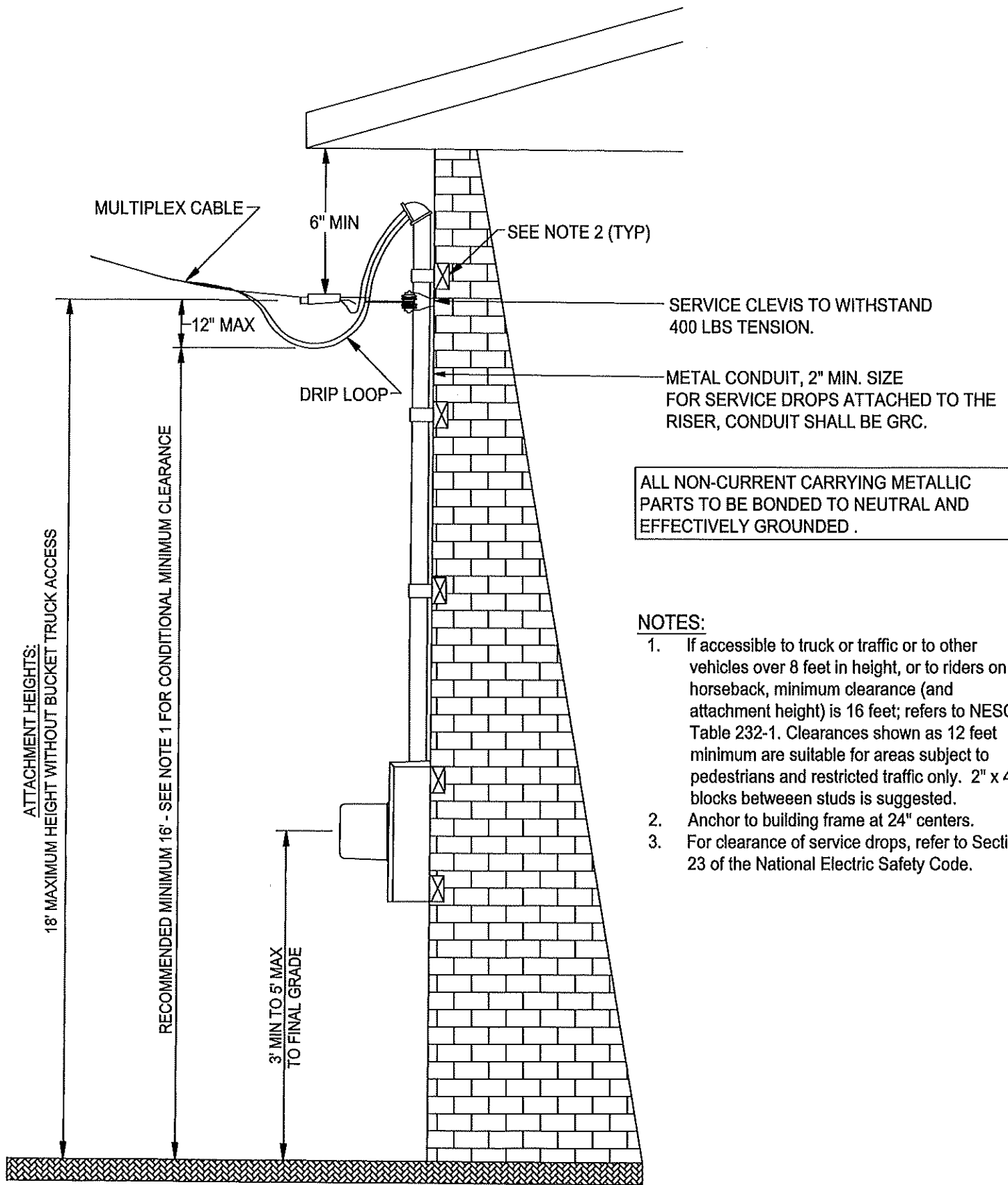

ALL NON-CURRENT CARRYING METALLIC PARTS TO BE BONDED TO NEUTRAL AND EFFECTIVELY GROUNDING .

- NOTES:**
1. If accessible to truck or traffic or to other vehicles over 8 feet in height, or to riders on horseback, minimum clearance (and attachment height) is 16 feet; refers to NESC Table 232-1. Clearances shown as 12 feet minimum are suitable for areas subject to pedestrians and restricted traffic only. 2" x 4" blocks between studs is suggested.
 2. Anchor to building frame at 24" centers.
 3. For clearance of service drops, refer to Section 23 of the National Electric Safety Code.

*NOT TO SCALE

ROCHESTER PUBLIC UTILITIES

NO	REVISION	BY	DATE
0	ORIGINAL DRAWING	BJK	05/01/2017
1	MISC. TEXT CHANGES	JA	02/09/2024

TYPICAL RESIDENTIAL UNDER EAVES SERVICE INSTALLATION

EXHIBIT 6.1

EXHIBIT 7

Clearance Requirements of Pad-Mounted Transformers

A minimum zone free of vegetation and obstructions shall be maintained around pad-mounted transformers. The minimum clearances around the transformer are 10 feet in front of the transformer doors and 2 feet from the sides and back of the transformer pad. These minimum clearances must be at the same grade as the transformer. Transformers shall not be located under any overhang (roof, balcony, stairs, etc.) without customer provided and installed provisions for setting/removal of the transformer and prior approval by RPU's Engineering Department.

Additional clearance requirements depicted on the following pages shall be met if the transformer is located near a structure.

CLEARANCES FOR OIL FILLED EQUIPMENT LOCATED NEAR BUILDINGS

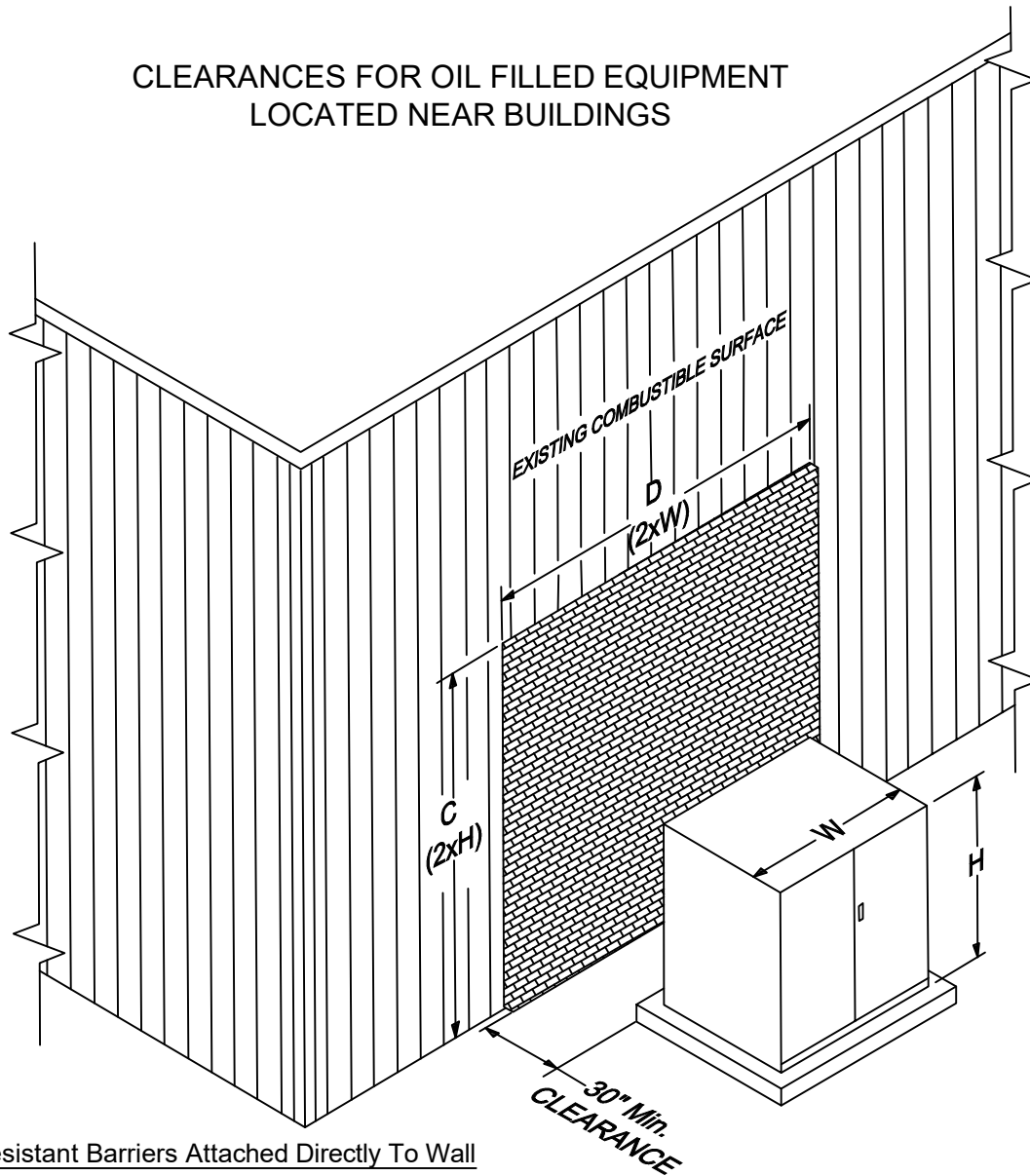

Fire Resistant Barriers Attached Directly To Wall

In locations where basic clearances cannot be met, a fire resistant barrier shall be installed either by the customer or at the customer's expense to reduce the required clearance to combustible walls, door air intakes or windows. The barrier shall be constructed of non-combustible material certified to have a 2 hour fire rating. It shall be of sufficient strength and have stability to resist tipping and satisfy Rochester building ordinances. If a specific ruling regarding fire ratings is necessary, contact the Rochester Fire Department. Engineering will coordinate the construction and location of the barrier, however the customer is responsible for all maintenance. The barrier will satisfy the following dimensional requirements:

H = Height in inches of oil filled equipment.

W = Width in inches of oil filled equipment.

C = Height of barrier required to obtain a projected height of two times the height of the oil filled equipment on the building wall (2 x H).

D = Width of barrier required to obtain a projected width of two times the width of the oil filled equipment on the building wall (2 x W).

ROCHESTER PUBLIC UTILITIES

NO	REVISION	BY	DATE
0	ORIGINAL DRAWING	BJK	05/01/2017

**CLEARANCES FOR OIL FILLED
EQUIPMENT NEAR BUILDINGS**

**EXHIBIT
7**

- I. **NONCOMBUSTIBLE WALLS:** (Included in this class would be wood framed brick veneered buildings, metal clad steel framed buildings, cement-board walled metal framed buildings, masonry buildings, and masonry buildings with a one (1) hour fire rating.)

Oil insulated, pad-mounted transformers may be located a minimum distance of 30" from noncombustible walls if all the clearances shown on this and the following drawings are maintained from doors, windows, and other building openings. A sump shall be installed for the transformer if the immediate terrain is not pitched away from the building. If a combustible first floor overhang exists, a 10' distance from the edge of the transformer to the edge of the overhang (combination of vertical and horizontal distance) shall be required in addition to the other clearances shown.

A. **Doors**

Oil insulated, pad-mounted transformers shall not be located within a zone extending 20' outward and 10' to either side of a building door.

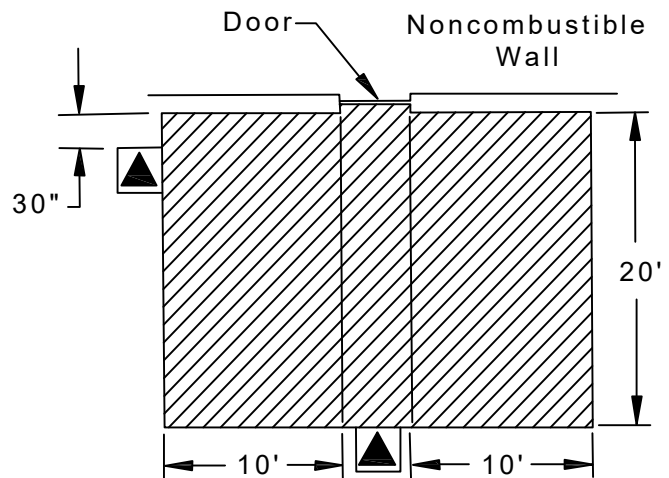

B. **Air Intake Openings**

Oil insulated, pad-mounted transformers shall not be located within a zone extending 10' outward and 10' to either side of an air intake opening located within 10' of the ground. If the air intake opening is located more than 10' above the ground, the distance from the transformer to the opening shall be a minimum of 25'.

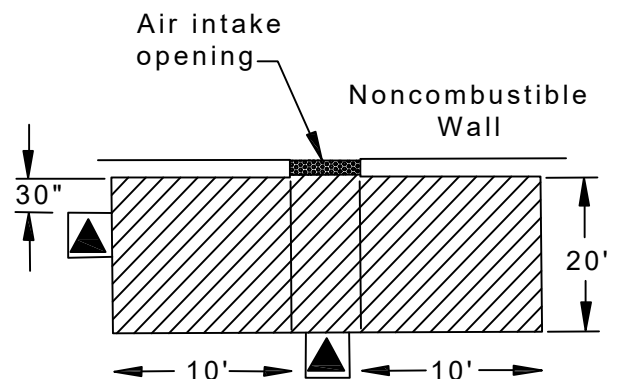

ROCHESTER PUBLIC UTILITIES

PAD-MOUNTED TRANSFORMER LOCATIONS

EXHIBIT
7
(Continued)

NO	REVISION	BY	DATE
0	ORIGINAL DRAWING	BJK	05/01/2017

C. Windows or Openings other than Air Intake

1. First Story

Oil insulated, pad-mounted transformers shall not be located within a zone extending 10' outward and 3' to either side of a building window or opening.

Window or opening other than air intake

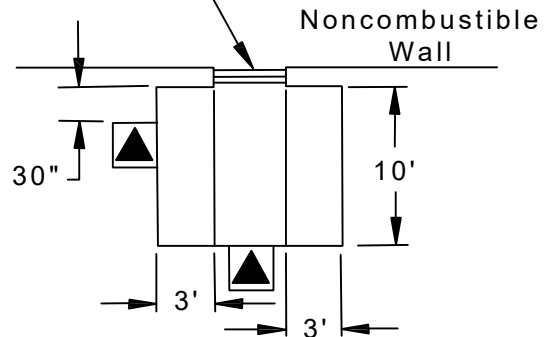

2. Second Story

Oil insulated, pad-mounted transformers shall not be located less than 5' from any part of a second story window or opening.

Oil filled equipment shall not be placed below an operating window on any floor. No exceptions will be made!

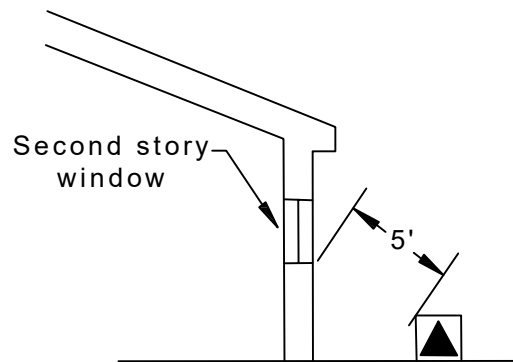

II. COMBUSTIBLE WALL

(Included in this class would be wood buildings and metal clad buildings with wood frame construction.) Oil insulated, pad-mounted transformers shall be located a minimum 10' from the building wall in addition to the clearance from building doors, windows, and other openings set forth for noncombustible walls. A sump shall be installed for the transformer if the immediate terrain is not pitched away from the building. If a combustible first floor overhang exists, a 10' distance from the edge of the transformer to the edge of the overhang (combination of vertical and horizontal distance) shall be required in addition to the other clearances as shown.

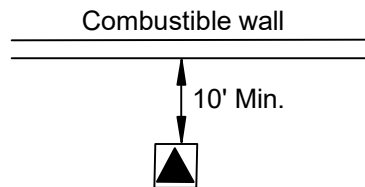

ROCHESTER PUBLIC UTILITIES

NO	REVISION	BY	DATE
0	ORIGINAL DRAWING	BJK	05/01/2017

PAD-MOUNTED TRANSFORMER LOCATIONS (CONTINUED)

EXHIBIT 7 (Continued)

III. BARRIERS

(Included in this class are reinforced concrete, brick, or concrete block barrier walls with a 3 hour fire rating.) If the clearance specified above cannot be obtained, a fire resistant barrier shall be constructed in lieu of the separation. The barrier (when required) is provided by the customer. The following methods of construction are acceptable.

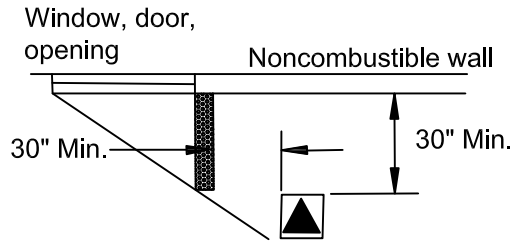

A. NONCOMBUSTIBLE WALL

The barrier shall extend to a projection line from the corner of the pad-mounted to the furthest corner of the window, door, or opening in question.

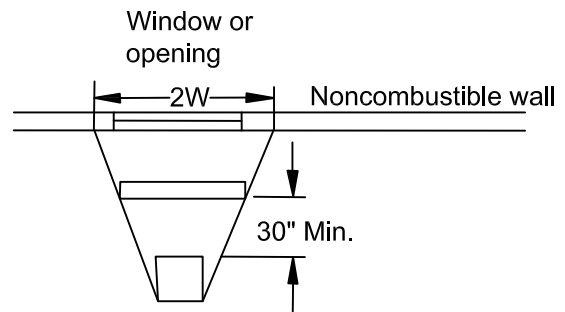
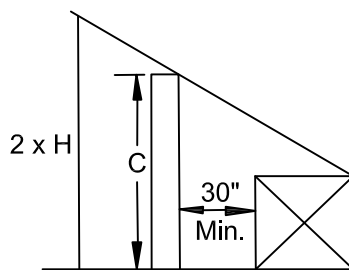

B. COMBUSTIBLE WALLS

The barrier shall extend 3' beyond each side of the oil insulated, pad-mounted transformer. The height of the barrier shall be 3' above the top of the pad-mounted transformer. If a combustible first floor overhang exists, the 24" specified shall be measured from the edge of the overhang rather than from the building wall.

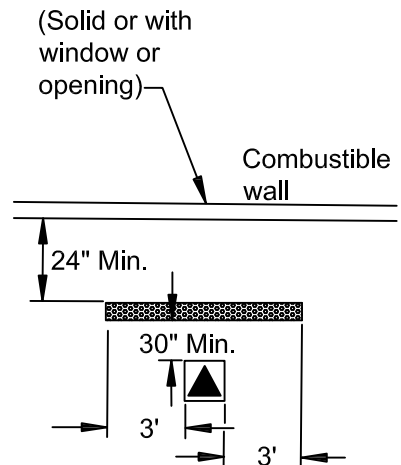

ROCHESTER PUBLIC UTILITIES

NO	REVISION	BY	DATE
0	ORIGINAL DRAWING	BJK	05/01/2017

PAD-MOUNTED TRANSFORMER LOCATIONS (CONTINUED)

EXHIBIT 7 (Continued)

IV. FIRE ESCAPES

Oil insulated, pad-mounted transformers shall be located such that a minimum clearance of 20' is maintained from fire escapes at all times.

Exception: Oil insulated, pad-mounted transformers may be located closer to a fire escape than the 20' minimum when a fire resistant barrier is constructed around the transformer (side walls and roof). The barrier shall extend a minimum of 1' beyond the transformer. The transformer and barrier shall not in any way obstruct the fire escape exit. 10' clearance is required in front of pad-mount transformer doors. Adequate transformer accessibility and ventilation must be provided. If transformer is installed underneath a fire escape, maintain 10' vertical clearance.

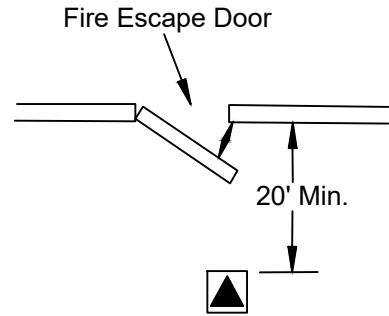

V. DECORATIVE COMBUSTIBLE ENCLOSURE

Decorative combustible enclosures (fence) installed by the customer around oil insulated, pad-mounted transformers adjacent to a combustible building wall shall not extend more than 24" beyond the transformer towards the combustible wall. 10' clearance is required in front of pad-mounted transformer doors. Adequate transformer accessibility and ventilation must be provided.

ROCHESTER PUBLIC UTILITIES

NO	REVISION	BY	DATE
0	ORIGINAL DRAWING	BJK	05/01/2017

PAD-MOUNTED TRANSFORMER
LOCATIONS (CONTINUED)

EXHIBIT
7
(Continued)

BOLLARD LAYOUT
(typical)

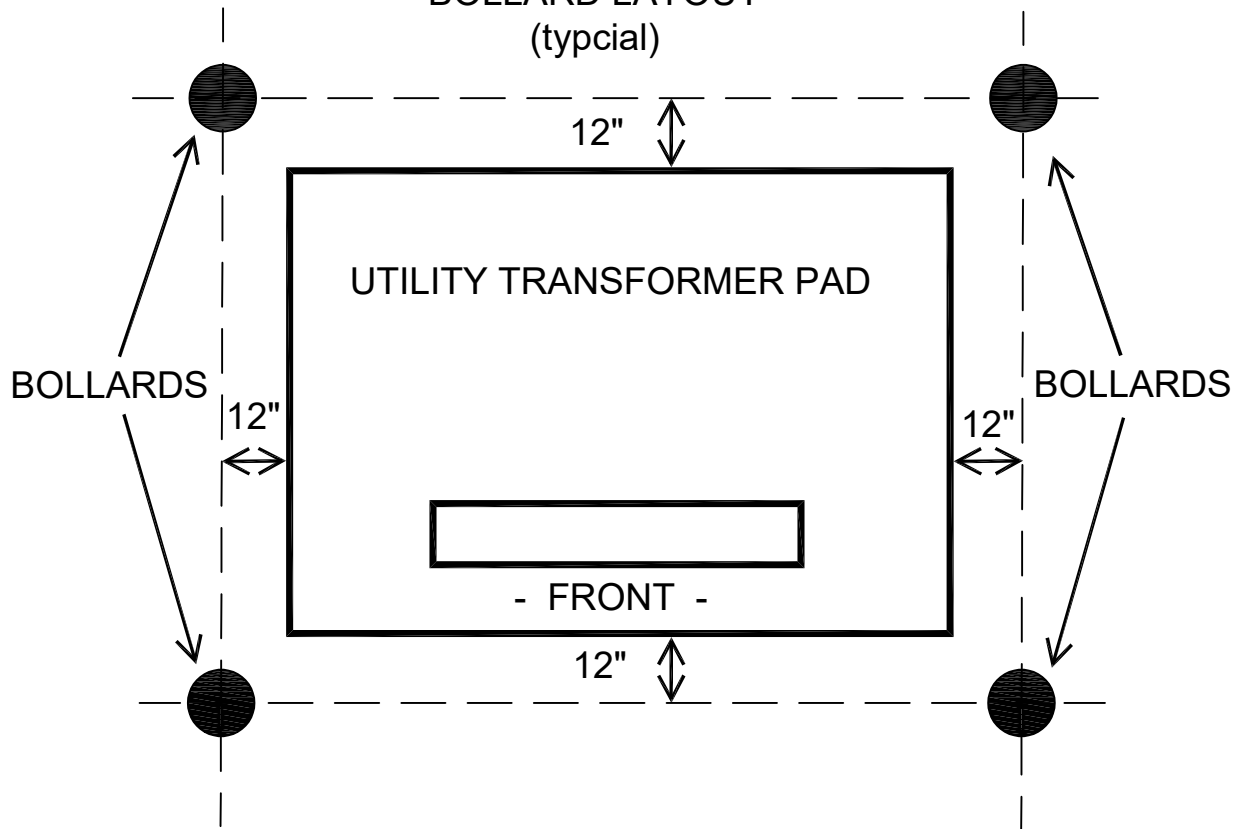

BOLLARD DETAIL
(typical)

5" ROUND RIGID
STEEL PIPE
CONCRETE FILLED

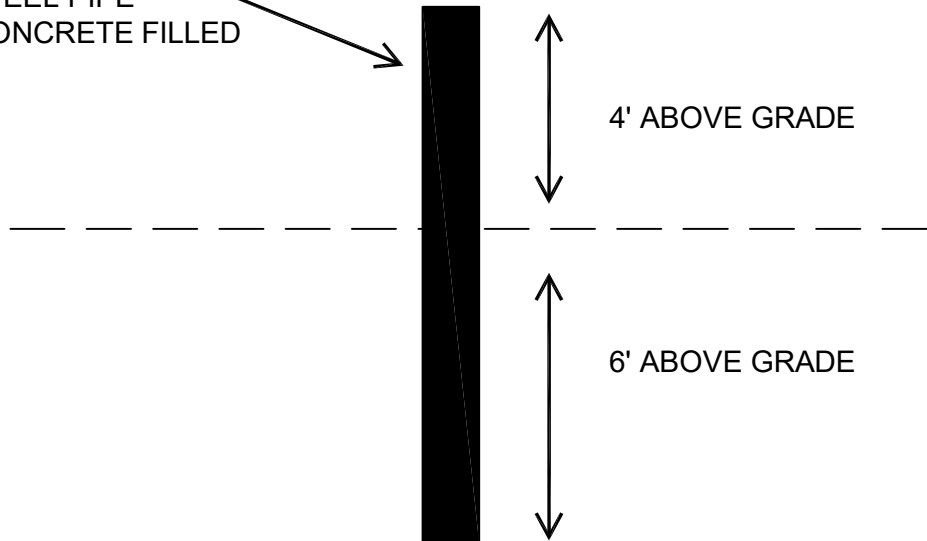

NOT TO SCALE

ROCHESTER PUBLIC UTILITIES

NO	REVISION	APPROVED BY	DATE
BK	DRAWING CREATED	JSA	5/21

TRANSFORMER PROTECTION

EXHIBIT

7.1

EXHIBIT 8

RPU AND CUSTOMER RESPONSIBILITIES ASSOCIATED WITH NON-SINGLE FAMILY RESIDENTIAL UNDERGROUND INSTALLATIONS

RPU RESPONSIBILITIES

1. Designate service location and/or transformer location.
2. Supply and install pad-mounted transformer.
3. Make all primary terminations and connections.
4. Connect the customer's secondary cable to the secondary terminals of the transformer only after customer's wiring has been approved by the inspecting authority.
5. Energize the service only when authorized to do so by the inspecting authority.
6. Supply and install all primary cable at no cost to the customer after said customer furnishes and installs conduit for the entire distance from the property line to the transformer.
7. Supply and install one meter set for each customer, including all meters required for billing purposes and any accessories such as totalizers, current and potential transformers, phase-shifting transformers, test switches, and color code meter wiring.
8. Inspect customer-furnished equipment required by RPU. Installations not in compliance with RPU regulations will be rejected.

CUSTOMER RESPONSIBILITIES

1. Contact RPU to obtain the location and routing of RPU's facilities and to fill out an Application for Service, Load Data Sheet and any other forms or statements required by RPU.
2. Provide necessary easements and clear area of all construction obstructions.
3. Bring area to final grade before installation of cable and transformers. Grade changes requiring cable adjustments will result in charges to the party requiring the changes.
4. Compaction along conduit route after installation of conduit is the customer's responsibility.
5. Furnish and install a transformer pad and ground rod to RPU specifications. Contact RPU to obtain the pad specifications and transformer location (transformer location shall be truck accessible and within 15 feet of a paved surface) for the specific service being installed. Notify RPU to inspect formed pad prior to pouring concrete.
6. Provide a location for the transformer(s) that meets the clearance requirements of Exhibit 7.
7. Provide easy accessibility to area 24 hours a day.
8. Furnish and install all secondary cables, cabinets, and conduits from the transformer to the building service entrance.

EXHIBIT 8 - Continued

9. Furnish and install electrical conduit per RPU's specifications (typically schedule 40 PVC 4" or larger) with marking tape to the point of interconnection with RPU. All conduit shall be installed a minimum of 36" below final grade. All radiuses less than 60" shall be factory fabricated and shall be made of schedule 40 galvanized rigid metallic conduit. Minimum elbow (bend) radius shall be 36 inches. Furnish and install pull rope in conduit.
10. Install protective bollards if RPU facilities (i.e. transformer, junction cabinet, pad-mount switchgear, etc.) will be installed in parking area or area subject to vehicular traffic.
11. Protect RPU facilities from damage during construction period.
12. Have all required inspections of facility performed and approved.
13. Notify RPU prior to any proposed building or grade changes within 10 feet of the electrical service or the cable route.
14. Supply and install RPU approved meter socket on outside wall or approved location and install conduit for service cable.
15. Notify RPU as far in advance as possible when any unusual loads are anticipated, such as special medical equipment, arc welders, elevators, or any other equipment that could affect RPU's system or any other customer.
16. Pay all applicable RPU fees.

EXHIBIT 9

RPU AND CUSTOMER RESPONSIBILITIES ASSOCIATED WITH UNDERGROUND SINGLE FAMILY RESIDENTIAL DISTRIBUTION (URD) INSTALLATIONS

RPU RESPONSIBILITIES

1. Designate point of delivery or transformer location.
2. Supply and install all primary cable, transformer pads, and pad-mounted transformers.
3. Make all primary terminations and connections and install the grounding system.
4. Connect customer's secondary cables to RPU's point of delivery after customer's wiring has been approved by the inspecting authority.
5. Install the meter and any other meter accessories needed for billing purposes, excluding the meter socket.
6. Energize the service only when authorized to do so by the inspecting authority.
7. Supply and install secondary connection pedestals and secondary cable to the pedestals.

CUSTOMER RESPONSIBILITIES

1. Contact RPU to obtain the location of RPU's facilities and customer service point and to fill out an "Application for Service," and any other forms or statements required by RPU.
2. Provide necessary easements and clear area of all construction obstructions.
3. Bring area to final grade before installation of cable and transformers. Install grade stakes at all front lot line property corners. Grade changes requiring cable adjustments will result in charges to the party requiring the changes.
4. In new developments, install road crossing conduits per Exhibit 12 as designated by RPU in the general development specifications.
5. Allow RPU to install cable/conduit prior to installation of sidewalks, soil or lighting along cable route.
6. Compaction of customer installed (buried) cable is customer's responsibility. (RPU will compact all primary and secondary cable it buries.)
7. Provide firm soil conditions under the pad area to prevent settling of the pad.
8. Provide a location for the transformer or secondary pedestal that meets the clearance requirements outlined in Exhibit 7.
9. Protect RPU facilities from damage during construction period.
10. Provide easy accessibility to the area 24 hours a day.
11. Have wiring approved by inspecting authority and then request service connection by RPU.
12. Install protective bollards if RPU facilities (i.e. transformer, junction cabinet, pad-mount switchgear, etc.) will be installed in parking area or area of vehicular traffic.

EXHIBIT 9 – Continued

13. Notify RPU prior to any proposed building or grade changes within 10 feet of the electrical service or the cable route.
14. Notify RPU as far in advance as possible when any unusual loads are anticipated, such as special medical equipment, arc welders, elevators, or any other equipment that could affect RPU's system or any other customer.
15. Supply and install an RPU approved meter socket on outside wall.
16. Supply all secondary cable extending from the meter to the RPU designated point of interconnection (transformer or secondary pedestal).
17. Contact RPU two (2) business days in advance when a service is to be installed so that RPU can schedule the meeting to provide access to the power source and the contractor can install the service into the power source.
18. Pay all applicable RPU fees.

EXHIBIT 10

INSTALLATION GUIDELINES

Scheduling:

1. RPU will install underground electric facilities on a first come - first served basis. If for some reason the site is not ready for the installation on the scheduled date it will be rescheduled to the end of the queue.
2. New Commercial/Residential Subdivisions are typically installed as joint installations with other utilities. These installations are jointly scheduled by the utilities and our contractor once certain site conditions are met. If for some reason the site is not ready for installation of all facilities on the scheduled date the installation will be rescheduled to the end of the queue.

3. Installation in Unsuitable Backfill Material:

The customer shall be required to pay an additional fee if unsuitable backfill material is encountered during the installation of RPU's facilities. The fee will be based on the cubic feet of unsuitable backfill material encountered by RPU or our contractor during installation. RPU may require that the Customer pay an estimated fee prior to performing the work.

4. Winter Installations:

The customer shall be required to pay a per-foot additional fee for underground cable installation, at the customer's request, after frost has been established in the ground to an average depth of 6 inches or more. The amount of the frost fee depends on the depth of the frost. RPU may require that the estimated frost charges be paid in advance of performing work.

Installations scheduled on or after the onset of frost will be attempted at the discretion of RPU, based on ground conditions.

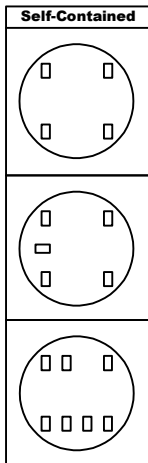

4 TERMINAL
120-240 VOLT, 277 VOLT
SINGLE PHASE

5 TERMINAL
120-208 VOLT
SINGLE PHASE
(Fifth Terminal needs to be located in the 9 O'Clock Position)

7 TERMINAL
120-208 VOLT
THREE PHASE, 4 WIRE
(Also 240 Volt, 4 Wire Delta)

SELF CONTAINED METERING NOTES:

- 1. All self contained meter sockets must contain a lever bypass and will need to be purchased by the Customer or Electrician.**
- 2. The maximum service size for a self contained metering application is 400A (Class 320 meter socket).**

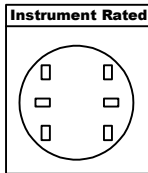

6 TERMINAL
120-240 VOLT
SINGLE PHASE

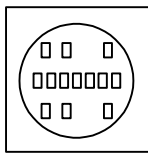

13 TERMINAL
120-208, 240, 277-480 VOLT
THREE PHASE, 4 WIRE

INSTRUMENT RATED METERING NOTES:

- 1. All instrument rated meter sockets will need to be purchased by the Customer or Electrician. RPU no longer sells meter sockets.**

ROCHESTER PUBLIC UTILITIES

REVISION	BY	DATE
0 ORIGINAL DRAWING	BLK	05/01/2017
1 REMOVED 8 TERMINAL SOCKET	JSA	12/23

METER SOCKET TYPES

EXHIBIT
11.0

ISSUED ON: 12/23

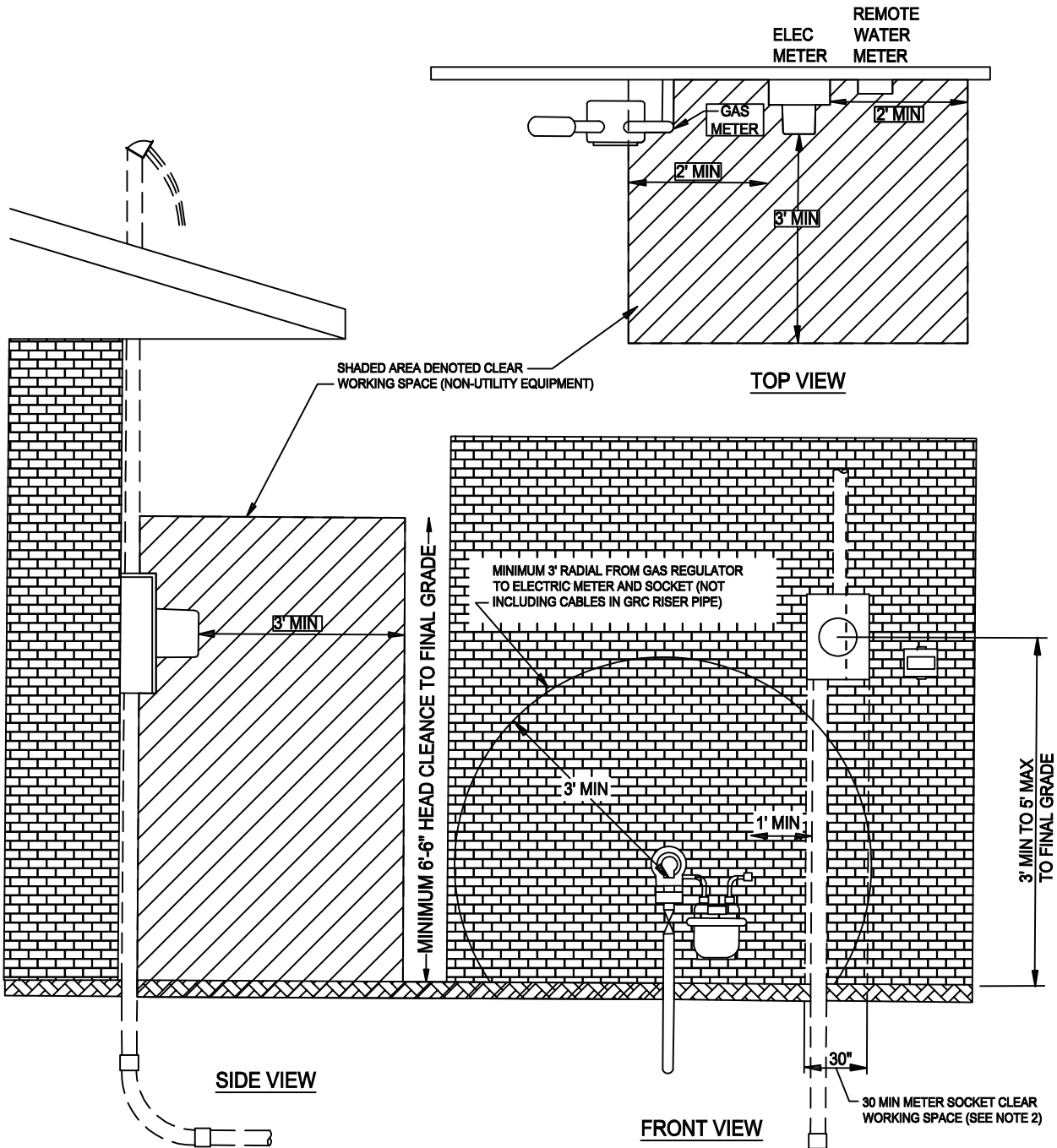

NOTES:

1. A 30" wide clear working space (includes the meter socket) along with 3' of clear area in front of the meter is required for all non-utility owned equipment. This clear working space shall extend from the final grade up to the required 6'-6" headroom clearance. Obstructions that can hinder maintenance or reading of meters such as shrubs, stairways, window wells, or other debris are prohibited within this clear space.
2. Rochester Building Department requires all above ground gas piping materials to be installed outside of 30" meter socket working space (see drawing).
3. These clearances apply to both overhead and underground services.

ROCHESTER PUBLIC UTILITIES

NO	REVISION	BY	DATE
0	ORIGINAL DRAWING	BJK	05/01/2017

REQUIRED METER WORKING AND SAFETY CLEARANCES

**EXHIBIT
11.1**