

VISTA-100

Commercial Fire and Burglary Partitioned Security System

User Guide

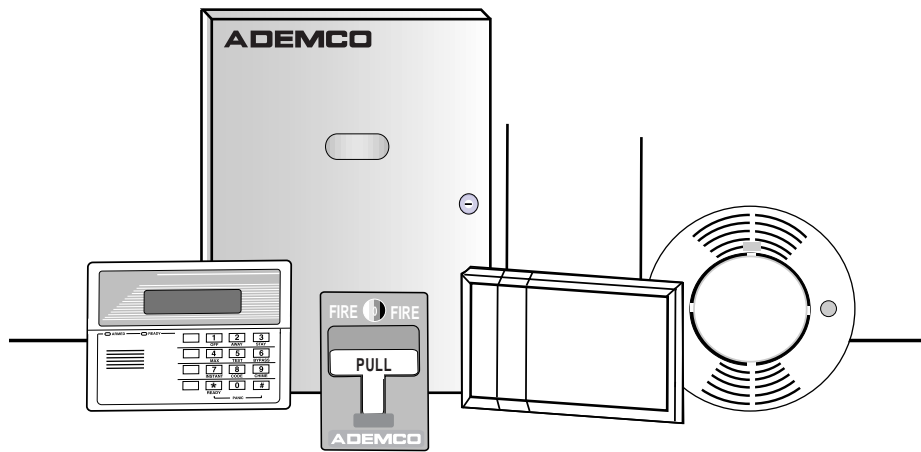

® ADEMCO

TABLE OF CONTENTS

<p>SYSTEM OVERVIEW 3</p> <p style="padding-left: 20px;">A Partitioned System 3</p> <p style="padding-left: 20px;">Zones 3</p> <p style="padding-left: 20px;">Fire Protection 4</p> <p style="padding-left: 20px;">Burglary Protection 4</p> <p style="padding-left: 20px;">Alarms 4</p> <p style="padding-left: 20px;">Memory of Alarm 4</p> <p style="padding-left: 20px;">Speed Key (Macros) 5</p> <p style="padding-left: 20px;">Using Schedules 5</p> <p style="padding-left: 20px;">Device Timers 5</p> <p style="padding-left: 20px;">Accessing other partitions (GOTO command) 5</p> <p style="padding-left: 20px;">Master Keypad Operation 6</p> <p style="padding-left: 20px;">Self-Help Feature 6</p> <p style="padding-left: 20px;">Phone Access & Voice Response 6</p> <p>ABOUT THE KEYPADS 7</p> <p>FUNCTIONS OF THE KEYPADS 8</p> <p>ENTRY/EXIT DELAYS 11</p> <p>SECURITY CODES & AUTHORITY LEVELS 12</p> <p style="padding-left: 20px;">Duress Code 12</p> <p style="padding-left: 20px;">Quick Arming 12</p> <p style="padding-left: 20px;">Authority Levels 13</p> <p style="padding-left: 20px;">To Add A User 15</p> <p style="padding-left: 20px;">To Change A User's Code 17</p> <p style="padding-left: 20px;">To Delete A User 17</p> <p>ACCESSING OTHER PARTITIONS 18</p> <p style="padding-left: 20px;">GOTO Command 18</p> <p style="padding-left: 20px;">Global Arming 18</p> <p style="padding-left: 20px;">Master Keypad Operation 19</p> <p style="padding-left: 20px;">Common Lobby Operation 20</p> <p style="padding-left: 20px;">How User Codes Affect the Common Lobby . 21</p> <p>CHECKING FOR OPEN ZONES 22</p> <p>DISPLAYING ALL ZONE DESCRIPTORS 23</p>	<p>BYPASSING PROTECTION ZONES 24</p> <p style="padding-left: 20px;">Quick Bypass 25</p> <p style="padding-left: 20px;">Displaying Bypassed Protection Zones 25</p> <p style="padding-left: 20px;">ARMING PERIMETER ONLY (STAY) 26</p> <p>ARMING PERIMETER ONLY (INSTANT) 27</p> <p>ARMING ALL PROTECTION (AWAY) 28</p> <p>ARMING ALL PROTECTION (MAXIMUM) 29</p> <p>DISARMING AND SILENCING ALARMS 30</p> <p>USING THE KEYSWITCH 31</p> <p>CHIME MODE 32</p> <p>VIEWING CENTRAL STATION MESSAGES 33</p> <p>PANIC KEYS 34</p> <p>SPEED KEY (MACROS) 35</p> <p>ACCESS DOOR CONTROL 36</p> <p>USING #70 RELAY MENU MODE 37</p> <p>USING SCHEDULES 38</p> <p style="padding-left: 20px;">Delaying The Closing Time 39</p> <p style="padding-left: 20px;">Temporary Open/Close Schedules 39</p> <p>PROGRAMMING DEVICE TIMERS 42</p> <p>TESTING THE SYSTEM 44</p> <p>TROUBLE CONDITIONS 46</p> <p>FIRE ALARM SYSTEM 48</p> <p>RECOMMENDATIONS FOR PROPER PROTECTYION 49</p> <p>EMERGENCY EVACUATION 51</p> <p>MAINTAINING YOUR SYSTEM 52</p> <p>QUICK GUIDE TO SYSTEM FUNCTIONS 54</p> <p>SUMMARY OF AUDIBLE NOTIFICATION 56</p> <p>GLOSSARY 57</p> <p>INSURANCE CREDIT REQUEST FORM 63</p> <p>INDEX 65</p> <p>ADEMCO LIMITED WARRANTY 66</p> <p>EVENT LOGGING COMMANDS 67</p>
--	--

SYSTEM OVERVIEW

General Congratulations on your ownership of an Ademco Partitioned Security System. You've made a wise decision in choosing it, for it represents the latest in security protection technology today. Ademco is the world's largest manufacturer of security systems and millions of premises are protected by Ademco systems.

This system offers you three forms of protection: burglary, fire and emergency. To realize the system's full potential, it is important that you feel comfortable in operating it. Your system consists of at least one Keypad which provides full control of system operation, various sensors which provide perimeter and interior burglary protection, plus a selected number of strategically placed smoke or combustion detectors designed to provide early warning in case of fire.

The system uses microcomputer technology to monitor all protection zones and system status and provides appropriate information for display on the Keypad(s) used with the system, and initiates appropriate alarms. Your system may also have been programmed to automatically transmit alarm or status messages over the phone lines to a central alarm monitoring station.

A Partitioned System Simply stated, a partitioned system shares one physical alarm system among different users, each with their own requirements. For the most part, you as a user need not know about other users and their structure in the system, but from time to time, you may see display messages which indicate the system is in use by another user. Do not be concerned, this is normal. Refer to the ACCESSING OTHER PARTITIONS section for additional information.

Zones Your system's sensing devices have been assigned to various "zones." For example, the sensing device on your Entry/Exit door may have been assigned to zone 01, sensing devices on windows in the master bedroom to zone 02, and so on. These numbers will appear on the display, along with an alpha descriptor for that zone (if programmed), when an alarm or trouble condition occurs.

SYSTEM OVERVIEW (cont'd)

Fire Protection The fire protection portion of your security system (if used) is always on and will sound an alarm if a fire condition is detected. Refer to the FIRE ALARM SYSTEM section for important information concerning fire protection, smoke detectors and planning emergency exit routes from your house.

Burglary Protection The burglary protection portion of your system must be turned on or "armed" before it will sense burglary alarm conditions. Your system provides four modes of burglary protection: STAY, AWAY, INSTANT and MAXIMUM, and even allows you to BYPASS selected zones of protection while leaving the rest of the system armed. The system also provides a CHIME mode, for alerting users to the opening and closing of doors and windows while the system is disarmed. Refer to the other sections of this manual for procedures for using these features.

The following table lists the four different arming modes and the results of each.

Arming Mode	Features For Each Arming Mode			
	Exit Delay	Entry Delay	Perimeter Armed	Interior Armed
AWAY	Yes	Yes	Yes	Yes
STAY	Yes	Yes	Yes	No
INSTANT	Yes	No	Yes	No
MAXIMUM	Yes	No	Yes	Yes

Alarms When an alarm occurs, both the keypad and external sounders will sound, and the keypad will display the zone(s) causing the alarm. If your system is connected to a central monitoring station, an alarm message will also be sent. To stop the alarm sounding, simply disarm the system.

Memory of Alarm When an alarm condition occurs, the keypad displays the number(s) of the zone(s) that caused the problem, and displays the type of alarm (ex. FIRE, ALARM). It remains displayed until it is cleared by disarming the system (see DISARMING THE SYSTEM section).

SYSTEM OVERVIEW (cont'd)

Speed Key (Macros)

The system can store a string of up to 16 keystrokes, which can be activated anytime by simply pressing the "**D**" key. This feature can be used to make it easy to perform a complicated procedure (such as going to another partition to bypass a zone), or it can be used to simplify an everyday, repeated procedure. Refer to the SPEED KEY section for procedures for using this feature.

Using Schedules

Your system may have been programmed with schedules for automatically arming, disarming and activating various devices and/or performing other system functions at predetermined times. Users can modify some of these schedules by manually delaying a closing time, using temporary schedules, or by programming special user schedules. Refer to the USING SCHEDULES section at the end of this manual for scheduling related procedures.

Device Timers

The system provides up to 20 "timers" which can be used to control various devices, such as lights or appliances. These timers are similar in concept to the individual appliance timers that might be purchased at a department store. The devices that can be controlled are programmed into the system by the installer. Up to 16 of these devices can be programmed. Refer to the PROGRAMMING DEVICE TIMERS section for procedures.

To Access Another Partition (GOTO Command)

Each keypad is assigned a default partition for display purposes, and will show only that partition's information. But, if the user is authorized, a keypad in one partition can be used to perform system functions in another partition by using the **GOTO** command. Note that only those partitions authorized and programmed by the installer can be accessed in this manner.

To **GOTO** another partition, enter your security code, then press  followed by the desired partition number (1-8).

The keypad will remain in the new partition until directed to go to another partition, or until 120 seconds has elapsed with no keypad activity. Entering partition number 0 will return the keypad to its original partition.

SYSTEM OVERVIEW (cont'd)

Master Keypad Operation

A "Master" keypad is one on which the status of all 8 partitions is displayed simultaneously. A user can get more information about a certain partition by simply entering  + the desired partition number (1-8). To log on to the "Master" partition (9) using the **GOTO** command, a user must have access to all partitions.

Self-Help Feature

Abbreviated user's instructions are built into the system that can be easily viewed on the alpha keypad's message display screen. This feature will prove particularly useful if this manual is not conveniently accessible when you need to perform a system procedure with which you are not familiar.

To view the abbreviated instructions:

Simply press and hold down the function key of interest until the description starts to appear (about 5 seconds) and then release it.

Refer to the FUNCTIONS OF THE KEYPAD section for descriptions of each key function.

Phone Access & Voice Response Capability

Your system may include a 4285 VIP module that will permit you to access the system via a Touch-tone phone, either on-premises or by call-in when away. The phone access feature will enable you to do the following:

- Receive synthesized voice messages over the telephone regarding the status of the security system.
- Arm and disarm the system and perform most function commands via the telephone, with voice confirmation provided after each command entry.
- Control 4204 relays through the #70 Manual Relay Activation mode.

Complete information regarding the use of this feature is provided in a separate manual entitled PHONE ACCESS USER'S GUIDE, which accompanies the 4285 VIP module.

ABOUT THE KEYPADS

General

IMPORTANT: If the keypad beeps rapidly upon entering the premises, it indicates that an alarm has occurred during your absence. LEAVE IMMEDIATELY and CONTACT THE POLICE from a nearby safe location.

Your keypads allow you to control all system functions. The keypads feature a telephone style (digital) keypad and a Liquid Crystal Display (LCD) which shows the nature and location of all occurrences. Keypad display back lighting is programmable to always stay on or to light only when a key is pressed, then turn off a few minutes later.

The keypads also feature a built-in sounder which will sound during alarms and troubles. It will also "beep" during certain system functions, such as during entry/exit delay times, during CHIME mode, and when depressing keys to arm and disarm the system (to acknowledge the key press). These sounds can be optionally suppressed in some of your keypads (so as not to disturb other users of the system). Ask your installer if this has been done.

The Keypad

This system uses alpha keypads, which feature a 2-line, 32 character alphanumeric Liquid Crystal Display (LCD). These keypads can display system messages in friendly English. Abbreviated user's instructions can also be displayed (see Self Help paragraph in the SYSTEM OVERVIEW section). These keypads can also be programmed with custom zone descriptors.

FUNCTIONS OF THE KEYPAD

1. **ALPHA DISPLAY WINDOW:** A 2-line, 32-character Liquid Crystal Display (LCD). Displays protection point identification and system status, messages, and user instructions.
2. **OFF KEY:** Disarms the burglary portion of the system, silences alarms and audible trouble indicators, and clears visual alarm trouble after the problem has been corrected.
3. **AWAY KEY:** Completely arms both perimeter and interior burglary protection by sensing an intruder's movements through protected interior areas as well as guarding protected doors, windows, etc. Late arrivals can enter through an entry delay zone without causing an alarm if the system is disarmed before the entry delay time expires.
4. **STAY KEY:** Arms the perimeter burglary protection, guarding protected doors, windows and other perimeter protection points, and sounds an alarm if one is opened. Interior protection is not armed, which allows movement within your house without causing an alarm. Late arrivals can enter through an entry delay zone without causing an alarm if the system is disarmed before the entry delay time expires.
5. **MAXIMUM KEY:** Arms in manner similar to AWAY mode, but eliminates the entry delay period, thus providing maximum protection. An alarm will occur immediately upon opening any protection point, including entry delay zones.
6. **TEST KEY:** Tests the system and alarm sounder if disarmed.
7. **BYPASS KEY:** Removes individual protection zones from being monitored by the system. Displays previously bypassed protection zones.
8. **INSTANT KEY:** Arms in manner similar to STAY mode, but turns off the entry delay period, offering greater security while inside and not expecting any late arrivals. An alarm will occur immediately upon opening any perimeter protection point, including entry delay zones.
9. **CODE KEY:** Allows the entry of additional user codes that can be given to other users of the system.
10. **CHIME KEY:** Turns on & off the CHIME mode. When on, any entry through a protected delay or perimeter zone while the system is disarmed will cause a tone to sound at the Keypad(s).
11. **READY KEY:** When depressed prior to arming the system, the keypad will display all open protection zones within the keypad's home partition. This key is also used to display all zone descriptors that have been programmed for your system, by holding the key down for at least 5 seconds.
12. **# KEY:** Permits ARMING of the system without use of a security code ("Quick Arm", if programmed).
13. **KEYS 0-9:** Used to enter your individual security access code(s).
14. **POWER/READY INDICATOR:** (GREEN) On some keypads, this lights when primary power is on. If off, system is operating on its backup battery power. CALL YOUR INSTALLER IMMEDIATELY. On other types of keypads, lit indicates system is ready to be armed, while unlit indicates system not ready.
15. **ARMED INDICATOR:** (RED) Lit when the system has been armed (STAY, AWAY, INSTANT or MAXIMUM).
16. **INTERNAL SOUNDER:** Source of audible internal warning and confirmation sounds, as well as alarms (see "Summary of Audible Notifications").
17. **A-B-C PANIC KEYS:** Refer to the PANIC KEYS section for descriptions of these keys.

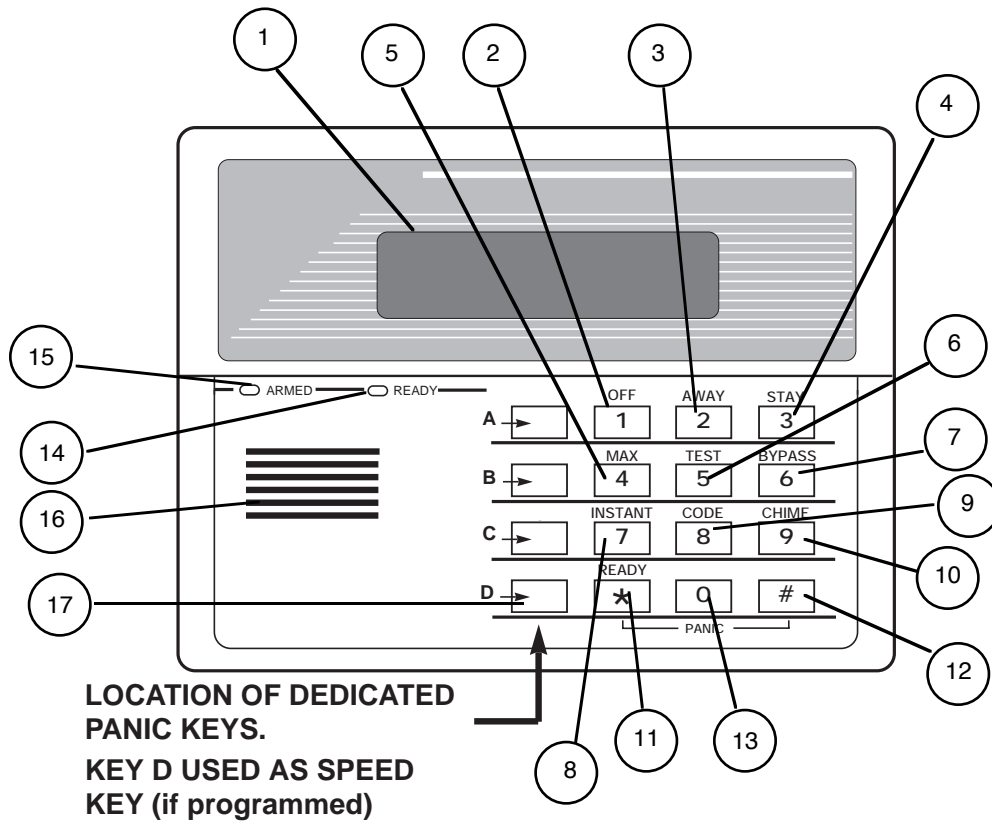

IMPORTANT!: When using the keypad to enter codes and commands, sequential key depressions must be made within 3 seconds of one another. If 3 seconds elapses without a key depression, the entry is aborted and must be repeated from its beginning.

ENTRY/EXIT DELAYS

General Information

Your system has preset time delays, known as exit delay and entry delay. Whenever you arm your system, **exit delay** gives you time to leave through the designated exit door without setting off an alarm. Exit delay begins immediately after entering any arming command, and applies to all modes of arming protection. If programmed, a slow beeping will sound throughout the exit delay period.

Entry Delay gives you time to disarm the system when you reenter through the designated entrance door. But the system must be disarmed before the entry delay period ends, or an alarm will occur. The keypad will beep during the entry delay period, reminding you to disarm the system. You can also arm the system with no entry delay at all by using either INSTANT or MAXIMUM arming modes. These modes provide greater security while on the premises or while away for extended periods of time. See your installer for your delay times.

SECURITY CODES & AUTHORITY LEVELS

General Information

At the time of installation, you were assigned an authority level and a personal four-digit security code, known only to you and yours. The security code must be entered when arming and disarming the system. The authority level defines the system functions that you can perform.

As an additional safety feature, other users that do not have a need to know your code can be assigned different security codes, and each user can be given a different authority level. Users are identified by "user numbers", which are assigned when assigning a user's security code.

All codes can be used interchangeably when performing system functions within the limits of each code's authority level (a system armed with one user's code can be disarmed by another user's code), with the exception of the Operator Level C code. See AUTHORITY LEVELS section on the following page for detailed information regarding user authority levels.

Duress Code

This feature is intended for use when you are forced to disarm or arm the system under threat. When used, the system will act normally, but can silently notify the central station of your situation, if that service has been provided. The duress code is pre-assigned by the installer during installation (auth. level 6).

Important: This code is useful only when the system is connected to a central station.

Quick Arming

Note that if "Quick Arming" was programmed by the installer, the key can be pressed in place of the security code when arming the system. The security code must always be used to disarm the system, however.

SECURITY CODES & AUTHORITY LEVELS (cont'd)

Authority Levels Authority levels define the system functions a particular user can perform. Depending on the authority assigned to you, there are certain system functions you may be prohibited from performing. In summary, there are six authority levels, each having certain system restrictions as shown below.

Level/Title	Arm/Disarm Burglary System	Silence Alarms, Supv & Trouble	Add/Change Security Codes	Bypass Zones	Activate Test Modes
1-Master	yes	yes	yes, levels 2-6 only	yes, burg zones (and fire zones if enabled)	yes, burg. walk test, fire drill
2-Manager	yes	yes	yes, levels 3-6 only	yes, burg zones only	yes, burg. walk test
3-Operator A	yes	yes	no	yes, burglary zones only	no
4-Operator B	yes	yes	no	no	no
5-Operator C	yes, can disarm only if used to arm	yes	no	no	no
6-Duress	yes, sends silent panic report	yes	no	no	no

To view your authority level and system capabilities:

1. Enter your code + + .
2. The keypad will display the partition(s) that you are authorized to operate, and your user number and authority level in each partition.

SECURITY CODES & AUTHORITY LEVELS (cont'd)

General Rules on Authority Levels and Changes

- A user may not delete or change the user code of the SAME or HIGHER authority than which he is assigned.
- A user may only ADD users to a LOWER authority level.
- A user may assign access codes only to those partitions to which the user adding the code has access. (ex. a user with access to only partition 1 cannot assign codes in partition 2.)
- The only way to assign a user's authority level is by using the "Add A User" procedure. To change a user's authority level, that user must first be deleted, then added again.
- A user can only be DELETED or CHANGED from within the partition he is assigned.
- User numbers must be entered as 3-digit entries. One- or two-digit user numbers must be preceded by a "0" (example, 003, 004, etc.). Security codes are entered as 4-digit numbers.
- Before assigning a security code, be sure it does not conflict with any DURESS code.

Note: When adding, changing or deleting users, all other alpha keypads in that partition will display "User Edit Mode – Please Stand By", and key depressions (except Panic) at those keypads will be ignored. Panic key depressions will cause an alarm and terminate user entry.

To Exit User Edit Mode

You can exit any of the user edit modes described on the following pages at any time by doing the following:

1. Press either * or #, or don't press any key for 10 seconds.
2. System returns to normal mode.

SECURITY CODES & AUTHORITY LEVELS (cont'd)

To Add a User **IMPORTANT:** Temporary users should not be shown how to use any system function they do not need to know (e.g. bypassing protection zones).

1. Enter Master or Manager code and press the CODE
8 key.
2. Enter the new user's 3-digit User Number (002-128).
3. Enter 4-digit security code for that user. The following prompts will appear.

ADD NEW USER?
0 = NO , 1 = YES

Enter 1 to add a new user code. Entering 0 will change the existing user's code to the code entered in step 3. See Changing A User's Code section.

USER NUMBER =
003
ENTER
AUTH.LEVEL

Enter the authority level, 1-6, for this user within this partition.

1=master	4=operator B
2=manager	5=operator C
3=operator A	6=duress code

RF BUTTON ?
0 = NO , 1 = YES

This prompt will appear if a 5800 series button transmitter has been supplied and has not yet been assigned to a user. Press 1 if a button transmitter will be assigned to this user. Otherwise press 0.

ENTER BUTTON
ZN #
(01-87)

If assigning a button transmitter, this prompt will appear. Enter the button's zone number (see your installer for zone number).

SECURITY CODES & AUTHORITY LEVELS (cont'd)

To Add a User
(continued)

MULTI-ACCESS ?
0 = NO , 1 = YES

If you as a user have access to other partitions, the keypad will prompt for ability of this new user to access (GOTO) those partitions. Press 0 (NO) or 1 (YES). If no, the system activates this user code and exits "Add a User" mode. If yes, the keypad prompts for the Global Arm option for this user.

GLOBAL ARM ?
0 = NO , 1 = YES

Press 1 (YES) if this user will be allowed to try to arm more than one partition at the same time. Press 0 if this user will arm only his assigned partition.

PART.2 - SHOP?
0 = NO , 1 = YES

The keypad now prompts for the user's access to the next partition (see GOTO command). Again press 0 or 1. If yes, the system will automatically assign a user number for use in that partition and will prompt for the authority level and global arm option for this user within the partition (see previous steps).

PART. 1 T WHSE
USER 003
AUTH=3G .

When all partitions have been displayed, the keypad will scroll through the partition(s) to which access has been assigned, and will display the user number, authority level and global arm option for each. The "G" after the authority level indicates that the global arm feature is active for this user in the displayed partition. The "*" indicates the partition from which this user can be changed or deleted. The "." at the end of the second line indicates that this user sends open/close reports. Open/close reporting is automatically active for any users added by you, if you have open/close reporting active.

SECURITY CODES & AUTHORITY LEVELS (cont'd)

To Change a User's Code

1. Enter Master or Manager code and press the ^{CODE} **8** key + user number to be changed.
2. Enter the new code for that user.

ADD NEW USER?
0 = NO , 1 = YES

The system will recognize that the user number is already in use and will prompt whether or not this is a new user. Enter 0 to change the existing user's code to the code entered in step 3.

USER 002
CHANGED
SUCCESSFULLY

The system will confirm that the change is allowed based on authorization level, and if so, will put the new code into effect.

Note that if changing one's own code, the system will prompt for the new code to be reentered. This prevents accidentally changing one's own code.

To Delete a User

1. Enter Master or Manager code and press the ^{CODE} **8** key + User Number to be deleted.
2. Enter Master or Manager code first entered.

OK TO DELETE
0 = NO , 1 = YES

The system will recognize that the User number is already in use and will prompt to confirm that it should be deleted. Press 0 (NO) or 1 (YES).

USER CODE
DELETED

If yes, that user's code will be removed from all partitions to which it was assigned, and all authorization levels and other information about that user will be deleted. Note that a user can only be deleted from the partition in which it was first assigned, and can only be deleted by a user with a higher authority level. A User's security code cannot be deleted by oneself.

ACCESSING OTHER PARTITIONS

(GOTO Command and Global Arming)

To Access Another Partition

Each keypad is assigned a default partition for display purposes, and will show only that partition's information. But, if the user is authorized, a keypad in one partition can be used to perform system functions in other partitions by using the **GOTO** command. Note that only those partitions authorized and programmed by the installer can be accessed in this manner.

To GOTO another partition:

1. Enter your security code, then press ★ + partition number (0-9).
Entering partition number 0 will return the keypad to its original partition.

READY

2.

LOG-ON TO
AAAA
PART. X
COMPLETE

The keypad will remain in the new partition until directed to go to another partition, or until 2 minutes has elapsed with no keypad activity.

AAAA = alpha descriptor programmed by the installer

X = partition number

Global Arming

The Global Arming option may have been programmed for use by some users. If Global Arming was enabled for use with your security code, a keypad prompt (message) will appear after pressing one of the arming function keys (STAY, INSTANT, AWAY, MAXIMUM, OFF). Follow the keypad prompts to continue arming the system. See your installer for detailed instructions on the use of this feature.

If global arming does not apply to your security code, use the procedures described in the following pages.

Master Keypad Operation

A "Master" keypad is one that reflects the status of the entire system (Partitions 1-8) on its display. This is useful because it eliminates the need for a security officer in a building to have to "log-on" to various partitions from one partition's keypad to find out where an alarm has occurred.

A description of a typical display follows:

SYSTEM 1 2 3 4 5 6 7 8
STATUS RRNNA *B

ACCESSING OTHER PARTITIONS (cont'd)

Master Keypad Operation (continued)

The status of each partition is directly below the partition number on the display. Possible status indications include:

A = Armed Away	M = Armed Maximum
S = Armed Stay	I = Armed Instant
R = Ready	N = Not Ready
B = Bypassed/Ready	T = Alarm Memory/Trouble present

To obtain more information regarding a particular partition, enter * + [Partition No.] (i.e., *4). This will allow viewing *only* of that partition. In order to affect that partition, the user must log on with a code that has access to that partition. Also, in order for a user of any partition to log onto the "Master" partition (Partition 9) to view the status of *all* partitions, that user must have access to all partitions. Otherwise, access will be denied.

The following is an example of what would be displayed for a fault condition on Zone 2 (Loading Dock Window) on Partition 1 (Warehouse) when logging on from a keypad on Partition 9:

```
WHSE DISARMED  
HIT * FOR FAULTS
```

This is the normal display that appears at Partition 1's keypad(s). Pressing * will display:

```
FAULT 02 LOADING  
DOCK WINDOW
```

Additional zone faults will be displayed one at a time. To display a new partition's status, press * + [Partition No.]. This will display the status of the new partition.

The "Armed" LED on a Master keypad will be lit only if *all* partitions have been armed successfully. The "Ready" LED will be lit only if *all* partitions are "ready to arm."

The sounder on a Master keypad will reflect the sound of the most critical condition on all of the partitions. The priority of the sounds is as follows:

- A. Pulsing fire alarm sounds
- B. Steady burglar alarm sounds
- C. Trouble sounds

The sounder may be silenced by pressing any key on the Master keypad.

ACCESSING OTHER PARTITIONS (cont'd)

Common Lobby Operation

When an installation consists of a partition shared by users of other partitions in a building, that shared partition may be assigned as the "common lobby" partition for the system. An example of this might be in a medical building where there are two doctor's offices and a common entrance area .

This option employs logic for automatic arming and disarming of the common lobby . Partitions may be set to affect and/or attempt to arm the common lobby. This will affect the way the lobby will react when arming or disarming activity occurs in another partition.

Partitions set to **affect** the lobby will cause the following to occur:

- a. When the first partition that affects the lobby is disarmed, the lobby will also be disarmed.
- b. The common lobby cannot be armed unless every partition selected to affect the lobby is armed.
- c. Arming the last partition that affects the lobby **will not** automatically attempt to arm the lobby.

Partitions set to **arm** the lobby will cause the following to occur:

- a. When the first partition that affects the lobby is disarmed, the lobby will also be disarmed.
- b. The common lobby cannot be armed unless every partition selected to affect the lobby is armed.
- c. Arming the last partition that is programmed to arm the lobby will automatically attempt to arm the lobby. If any faults exist in the lobby partition, or another partition that affects the lobby is disarmed, the lobby cannot be armed, and the message "UNABLE TO ARM LOBBY PARTITION" will be displayed.

ACCESSING OTHER PARTITIONS (cont'd)

The following chart sums up how the common lobby partition will operate.

Partition Affects Lobby	Partition Arms Lobby	Disarms when partition disarms?	Attempts to arm when partition arms?	Can be armed if other partitions
NO	NO	NO	NO	YES
YES	NO	YES	NO	NO
YES	YES	YES	YES	NO
NO	YES	--ENTRY NOT ALLOWED--		

How User Codes Affect the Common Lobby

Codes with "Global" Arming

If your code is given "global arming" when it is defined the keypad will ask "Arm all?" or "Disarm all?" whenever you try to arm or disarm the partitions you have access to from an alpha keypad. This allows you to pick and choose the partitions to be armed or disarmed, and so eliminates the "automatic" operation of the lobby. Keep in mind, however, that if attempting to arm all, and another "affecting" partition is disarmed, you will not be able to arm the lobby, and the message "UNABLE TO ARM LOBBY PARTITION" will be displayed.

Codes with "Non-Global" Arming

If arming with a non-global code, or if arming with a global code from a non-alpha keypad, the lobby partition operation will be automatic, as described in the previous table.

Other Methods of Arming/Disarming

When arming or disarming a partition that affects and/or arms the common lobby in one of the following manners, lobby logic remains active:

- Quick-Arm
- Keyswitch
- Wireless Button
- Wireless Keypad

CHECKING FOR OPEN ZONES

Using the 
READY Key

Before arming your system, all protected doors, windows and other protection zones must be closed or bypassed (see BYPASSING section). Otherwise the keypad will display a "Not Ready" message. Using the **READY** key will display all zones that are faulted, making it easier for you to secure any open zones.

To show faulted zones:

DISARMED -
PRESS
* TO SHOW
FAULTS

Note: Some keypads light a green LED when the system is ready. If not lit, the system is not ready to be armed.

1. Do not enter security code, but simply press  ^{READY} .

FAULT 005
FRONT
UPSTAIRS
BEDROOM

Typical fault display

2.

DISARMED
READY TO ARM

Secure or bypass the zones displayed before arming the system. The "Ready" message will be displayed[†] when all protection zones have been either closed or bypassed.

† NOTE: All or part of this message may be replaced by a customized message programmed by the installer. Bear this in mind whenever the instructions indicate that the "DISARMED" or "READY" message will be displayed.

DISPLAYING ALL ZONE DESCRIPTORS

Using the 
READY Key

The Alpha Keypads can also display all the zone descriptors that are programmed in your system. The abbreviated instructions for the **READY** key will appear first, followed by the zone descriptors. Displaying all descriptors is useful when you need to know the zone number of a particular zone, as when bypassing zones.

The "Disarmed-Ready to arm" message must be displayed before zone descriptors can be displayed.

Press the  key and hold down for at least 5 seconds.

BYPASSING ZONES

Using the 6 BYPASS Key

This key is used when you want to arm your system with one or more zones intentionally unprotected. Bypassed zones are unprotected and will not cause an alarm when violated while your system is armed. All bypasses are removed when an OFF sequence (security code plus OFF) is performed. Bypasses are also removed if the arming procedure that follows the bypass command is not successful.

To Bypass a Zone:

1. Enter the security code. Then press BYPASS [6] and enter the 3-digit number(s) of zone to be bypassed (ex. 005).

2. BYPASS 007
FRONT
UPSTAIRS
BEDROOM

Typical bypass message

All bypassed zones will be sequentially displayed when you are finished entering the number of zones to be bypassed. The console will then display a bypass message as a reminder that one or more zones is bypassed.

3. DISARMED
BYPASS
READY TO ARM

Arm the system as usual when the keypad displays the "ready" to arm message. Bypassed zones are unprotected and will not cause an alarm when violated while your system is armed.

Note: All system zone bypasses are removed when an OFF sequence (security code + OFF) is performed.

Quick Bypass:

Your system allows you to easily bypass all open (faulted) zones without having to enter zone numbers individually.

Note: All bypasses are removed when an OFF sequence (security code + OFF) is performed.

To use the Quick Bypass feature:

1. Enter your security code and press 6 then press ^{BYPASS}#. All bypassed zones will be sequentially displayed as when bypassing individual zones (described previously).

BYPASSING ZONES (cont'd)

Bypassing System Supervisory Zones

NOTE: Ask your installer if your system was set up to allow system zones and system outputs to be bypassed.

Your system may allow you to bypass certain "system zones" which monitor various aspects of system status and certain system outputs which annunciate system status. These zones and outputs are listed below. This feature is used to disable the monitoring of one or more system zones or to disable the operation of one or more system outputs when, for example, the system is to be serviced or tested. If enabled, this feature can only be used by a master user.

- zone #970: monitors the supervision status of the bell 1 output (if enabled at installation time). Bypassing this zone disables the operation and supervision of the bell 1 output.
- zone #971: monitors the supervision status of the bell 2 output (if enabled at installation time). Bypassing this zone disables the operation and supervision of the bell 2 output.
- zone #972: monitors the panel's field wiring to determine if a short to earth ground exists. Bypassing this zone disables earth ground fault monitoring.
- zone #973: monitors devices that your installer has connected to input 1 on the main PCB J2 connector (such as a back-up ALARMNET radio transmitter). Bypassing this zone causes the system to ignore the status of devices connected to input 1.
- zone #974: monitors the supervision status of the main dialer output (if enabled at installation time). Bypassing this zone disables the operation and supervision of the main dialer output.
- zone #975: monitors the supervision status of the back-up dialer output (if installed and enabled at installation time). Bypassing this zone disables the operation and supervision of the back-up dialer output.
- zone #976: this zone is assigned to the auxiliary relay output. Actually, this zone does not monitor anything since the auxiliary relay output is not supervised. However, bypassing this zone allows the operation of the auxiliary relay output to be disabled.
- zone #977: this zone is assigned to the ALARMNET radio trigger outputs. Actually, this zone does not monitor anything since the ALARMNET triggers are not supervised. However, bypassing this zone allows the operation of the triggers to be disabled.

BYPASSING ZONES (cont'd)

Displaying Bypassed Zones

Used to determine what zones have been previously bypassed. Bypassed zones can be displayed only when system is disarmed.

1. Enter your security code and press 6 ^{BYPASS}.
2. Wait for all bypassed zones to be sequentially displayed.

ARMING PERIMETER ONLY (With Entry Delay ON)

Using the **3**
STAY key

Use this key when you are staying home, but might expect someone to use the entrance door later.

When armed in STAY mode, the system will sound an alarm if a protected door or window is opened, but you may otherwise move freely throughout the premises. Late arrivals can enter through the entrance door without causing an alarm, but they must disarm the system within the entry delay period or an alarm will occur.

Close all perimeter windows and doors before arming (see CHECKING FOR OPEN ZONES section)

1. Enter your security code and press ^{STAY} **3**.
2.

ARMED ***STAY*** ZONE BYPASSED

 The keypad will beep three times and will display the armed message.
Note: "ZONE BYPASSED" in this display simply indicates that the interior zones of protection are not armed when using STAY mode.

ARMING PERIMETER ONLY (With Entry Delay OFF)

7 Using the INSTANT Key

Use this key when you are staying home and do not expect anyone to use the entrance door.

When armed in INSTANT mode, the system will sound an alarm if a protected door or window is opened, but you may otherwise move freely throughout the premises. The alarm will also sound immediately if anyone opens the entrance door.

Close all perimeter windows and doors before arming (see CHECKING FOR OPEN ZONES section)

1. Enter your security code and press ^{INSTANT} **7** .

2. **ARMED *INSTANT*
ZONE BYPASSED** The keypad will beep three times and will display the armed message.

Note: "ZONE BYPASSED" in this display simply indicates that the interior zones of protection are not armed when using STAY mode.

ARMING ALL PROTECTION (With Entry Delay ON)

2 Using the AWAY Key

Use this key when no one will be staying on the premises.

When armed in AWAY mode, the system will sound an alarm if a protected door or window is opened, or if any movement is detected inside the premises. You may leave through the entrance door during the exit delay period without causing an alarm. You may also reenter through the entrance door, but must disarm the system within the entry delay period or an alarm will occur.

Close all perimeter windows and doors before arming (see CHECKING FOR OPEN ZONES section)

1. Enter your security code and press ^{AWAY} 2 .

2.

ARMED **AWAY** YOU MAY EXIT NOW

The keypad will beep twice and will display the armed message.

Note: The "YOU MAY EXIT NOW" portion of the message disappears when exit delay expires.

ARMING ALL PROTECTION (With Entry Delay OFF)

4 Using the MAXIMUM Key

Use this key when the premises will be vacant for extended periods of time such as vacations, etc., or when no one will be moving through protected interior areas.

When armed in MAXIMUM mode, the system will sound an alarm if a protected door or window is opened, or if any movement is detected inside the premises. You may leave through the entrance door during the exit delay period without causing an alarm, but an alarm will be sounded as soon as someone reenters.

Close all perimeter windows and doors before arming (see CHECKING FOR OPEN ZONES section)

1. Enter your security code and press ^{MAXIMUM} 4 .

2.

ARMED *MAXIMUM* YOU MAY EXIT NOW

 The keypad will beep twice and will display the armed message.
Note: The "YOU MAY EXIT NOW" portion of the message disappears when exit delay expires.

DISARMING AND SILENCING ALARMS

1 Using the OFF Key

The **OFF** key is used to disarm the system and to silence alarm and trouble sounds. See "SUMMARY OF AUDIBLE NOTIFICATION" section for information which will help you to distinguish between FIRE and BURGLARY alarm sounds.

IMPORTANT: If you return and the main burglary sounder is on, DO NOT enter the premises, but call the police from a nearby safe location. If you return after an alarm has occurred and the main sounder has shut itself off, the keypad will beep rapidly upon entering, indicating that an alarm has occurred during your absence. LEAVE IMMEDIATELY and CONTACT THE POLICE from a nearby safe location.

To disarm the system and silence burglary or fire alarms:

1. Enter your security code and press ^{OFF} .

DISARMED
READY TO ARM

2. The Ready message will be displayed (if no alarms have occurred while armed) and the keypad will beep once to confirm that the system is disarmed.

Memory of Alarm

The keypad displays the zone number and type of alarm for any zone that has an alarm condition. These messages will remain displayed until cleared by a user. If an alarm has occurred, note the zone number displayed on the keypad and repeat step 1 above to clear the "Memory of Alarm" and restore the Ready message display. If the Ready message will not display, go to the displayed zone and remedy the fault (close windows, etc.). If the fault cannot be remedied, notify the alarm agency.

If the system was armed when the alarm occurred, repeat step 1 twice: once to disarm the system, a second time to clear the display.

USING THE KEYSWITCH

General Your system may be equipped with a keyswitch for use when arming and disarming. A red and green light on the keyswitch plate indicate the status of your system as follows:

Green Light: Lights when the system is **disarmed and ready** to be armed (no open zones). If the system is disarmed and the green light is off, it indicates the system is not ready (one or more zones are open).

Red Light: Lights when system is armed or memory of alarm exists.

Lit Steady: System is **armed in AWAY** mode.

Slow Flashing: System is **armed in STAY** mode.

Rapid Flashing: Memory of alarm, indicating an alarm has occurred .

Arming **To arm in the AWAY mode**, turn the key to the right for 1/2 second and release. Keypads will beep twice and the red light will stay on steady.

To arm in the STAY mode, turn the key to the right and hold for longer than 3 seconds, then release. Keypads will beep three times and the red light will flash slowly.

Disarming **To disarm the system**, turn the key to the right and release. If an alarm has occurred, the red light will be flashing rapidly (memory of alarm).

CHIME MODE

Using the **9** Key

Your system can be set to alert you to the opening of a door or window while it is disarmed by using CHIME mode. When activated, three tones will sound at the Keypad whenever a protected perimeter door or window is opened, and the Not Ready message will be displayed. Pressing the **READY** key will display the open protection points.

Note that Chime mode can be activated only when the system is disarmed.

1. **To turn Chime Mode on**, enter the security code and press

9.

CHIME MODE ON

The CHIME MODE ON message will appear for about two seconds then disappear. To display this message again (to determine whether chime mode is on or off), simply press and hold down the **CHIME key** for 5 seconds.

2. **To turn Chime Mode off**, enter the security code and press

9 again.

CHIME MODE OFF

The CHIME MODE OFF message will appear for about two seconds then disappear. To display this message again (to determine whether chime mode is on or off), simply press and hold down the **CHIME key** for 5 seconds.

VIEWING CENTRAL STATION MESSAGES

General Information

Users of the system may periodically receive messages on their display screens from their monitoring agency or installer. When a message is waiting to be viewed, the message shown below will appear.

MESSAGE. PRESS 0
FOR 5 SECS.

1. Press and hold down key for 5 seconds.
2. The message could take up to four screens to display all the information available.

PANIC KEYS

(FOR MANUALLY ACTIVATING SILENT AND/OR AUDIBLE ALARMS)

Using Panic Keys

Your system may have been programmed to use special key combinations to manually activate panic functions. The functions that might be programmed are Silent Emergency, Audible Emergency, Personal Emergency, and Fire. See your installer for the function(s) that may have been programmed for your system.

Active Panic Functions

(your installer should note which function(s) is active in your system)

Keys	Zone	Function
1 and ★	95	
3 and #	96	
★ and #	99	
A*	95	
B*	99	
C*	96	

* May not be present on your keypad(s).

To use a paired key panic function, simply press both keys of the assigned pair at the same time. If your keypad(s) have lettered keys for panic functions, press the designated key and hold down for at least 2 seconds to activate the panic function.

A silent emergency sends a silent alarm signal to the central station, but there will be no audible alarms or visual displays.

An audible emergency sends an emergency message to the central station (if connected) and will sound a loud, steady alarm at your keypad **and** at any external sounders that may be connected (**ALARM** plus a zone number would also be displayed).

A personal emergency alarm sends an emergency message to the central station (if connected) and will sound at Keypads, but not at external bells or sirens. (**ALARM** plus a zone number would also be displayed)

A fire alarm sends a fire alarm message to the central station and will uniquely sound external bells and sirens (**FIRE** plus a zone number would also be displayed).

SPEED KEY (MACROS)

General Information

The "D" key can be used to activate a string of commands up to 16 keystrokes. These commands are known as a macro and are stored in the system's memory. Typical Speed Key functions include:

- Seldom used but repeatable sequences.
- Arming sequences that involve first bypassing certain zones before arming.
- Relay activation sequences.

Defining

Enter your user code + [#] + [D] and hold the [D] key down until the following appears:

ENTER SPEED KEY "D"
existing sequence displayed

Enter up to 16 keystrokes. A speed key sequence can include different commands. Press the "D" key to separate different commands.

For example, you may want to perform the following sequence.

GOTO partition 2.....Enter *2
Bypass zones 10 & 11.....Press bypass [6], then the zone numbers 10 & 11
Arm in maximum mode.....Press maximum [4] key
Return to partition 1Enter *1

To program this sequence, type the following :

*2[D]61011[D]4[D]*1[D][D]

Note that the "D" key is pressed after the "2," the last "1" and the "4," separating the different commands. Press "D" twice to complete the entry and exit.

Executing

Press and hold down the "D" key (about 2 seconds) until the following prompt appears:

ENTER USER CODE

Enter your user code. The defined speed key sequence will begin automatically.

NOTE: When defining speed key sequences, do not use the [#] key to represent Quick Arming. The system uses the code entered at the prompt to initiate commands in a speed key sequence. The system interprets the use of the [#] key in a speed key sequence as its designated function only.

ACCESS DOOR CONTROL

**General
Information**

Your system may be set up such that a locked access door (such as in a lobby) can be unlocked using a keypad command. Ask your installer if this has been done in your system.

To activate this command:

Enter your security code and press .

The door will unlock for 2 seconds.

USING #70 RELAY MENU MODE

General Information

Your system may be set up so that certain lights or other devices can be turned on or off by using the #70 command from either a keypad or a telephone keypad (if 4285 VIP module is used). Ask your installer if this has been done in your system.

To activate relays from a keypad, enter 4-digit security code + [#] +70. Follow the keypad prompts described below.

To activate relays using a telephone and 4285 VIP module, first dial the 2-digit phone access code. When the system acknowledges the access, enter 4-digit security code + [#] + 70. The following prompts/voice responses will begin.

ENTER DEVICE NO. 00=QUIT 01

Voice: "ENTER DEVICE CODE NOW"

Enter the 2-digit number of the device to be activated.

Note that if an invalid number is entered, the system will simply ask you to reenter the number.

NN DEVICE IS OFF HIT 0=OFF , 1=ON

Voice: " <i>voice descriptor</i> DEVICE nn ON/OFF. FOR <i>voice descriptor</i> ON ENTER 1, FOR <i>voice descriptor</i> OFF ENTER 0"
--

Press 0 or 1 to turn the device off or on respectively.

"nn" represents the 2-digit device number and *voice descriptor* is the relay voice descriptor programmed by the installer.

NN DEVICE IS OFF HIT THE "*" KEY
--

Voice: " <i>voice descriptor</i> DEVICE nn ON/OFF. TO EXIT ENTER 00 NOW"

From a keypad, press * to continue. The ENTER DEVICE NO. prompt will appear.

From a telephone keypad, enter 00 to exit, or enter the next relay number to be programmed. The current on/off state of that relay will be annunciated as described above. Alternatively, if 6 seconds elapses with no key depression, the 4285 VIP module will annunciate the "ENTER DEVICE CODE NOW" message.

USING SCHEDULES

Delaying the Closing Time

Your system's programmed schedules may automatically arm the system at a predetermined time. In the event a user must stay on the premises later than usual, users with master or manager authority levels can manually delay the automatic arming (closing) time up to 2 hours.

To delay the closing time

1. Enter your security code (master or manager authority levels only).
2. Press the key, followed by **82**.
3. A menu prompt will be displayed, asking for the number of hours of delay.

```
CLOSING
DELAY?
HIT 0-2 HOURS
```

Enter the desired number of hours of delay, 1 or 2. The system will automatically exit this mode after entry.

Note that the delay is from the **scheduled closing time**, not from the time the command is entered.

IMPORTANT: The selected delay cannot be **reduced** once it is set. A 1 hour delay can be **increased** to 2 hours, though.

4. The system will automatically send a message to the central station informing them that the programmed schedule has been changed.

USING SCHEDULES (cont'd)

Temporary Open/Close Schedules

Temporary schedules allow you to override the normal schedules programmed by the installer. Temporary schedules can be in effect for up to one week, and take effect as soon as they are programmed.

Schedules are comprised of an arming (closing) time window and a disarming (opening) time window. A time window is simply a defined period of time, at the end of which arming or disarming will occur.

Before programming a temporary schedule, use a worksheet similar to the one below to plan your schedule. This will make it easier when actually programming the schedule.

Arm/Disarm	Mon	Tue	Wed	Thu	Fri	Sat	Sun
Windows							
Disarm Window							
Start Time HH:MM							
Stop Time HH:MM							
Arm Window							
Start Time HH:MM							
Stop Time HH:MM							

USING SCHEDULES (cont'd)

Programming Temporary Schedules

Temporary schedules only affect the partition from which it is entered. Temporary schedules can be reused at later dates simply by scrolling (by pressing #) to the DAYS? prompt (described below) and activating the appropriate days. This should be considered when defining daily time windows. Note that only users with authority level of manager or higher can program temporary schedules.

To program temporary schedules:

1. Enter your security code.
2. Press the **#** key followed by **81**.
3. The following prompts will appear.

MON	DISARM
WIND.	
07:45AM	08:45AM

The cursor will be positioned on the tens of hours digit of the start time for Monday's disarm window. Enter the desired hour. Press * to move to the minutes field. The minutes are entered in the same manner. The AM/PM indication is changed by hitting any key, 0-9, while the cursor is under the letter A/P position. Repeat for the stop time entry. Press the * key to move to the arming window for Monday.

Press # to move to the next screen display without making changes.

MON	ARM
WINDOW	
07:45AM	08:45AM

The cursor will be positioned on the tens of hours digit of the start time for the arm window. Repeat the previous steps to enter the start and stop time for Monday's arming window.

USING SCHEDULES (cont'd)

Programming Temporary Schedules (continued)

```
TUE   DISARM
WIND.
07:45AM
08:45AM
```

```
D A Y S      ?
MTWTFSS
HIT 0-7 X X
```

After the windows for that day have been completed, the system will prompt for disarm and arm time windows for the next day. Repeat the procedure for all days of the week.

When all of the days have been completed, the system will ask which days are to be activated.

This is the prompt that actually activates the temporary schedule, and allows the temporary schedule to be customized to a particular week's needs. To select the days which are to be activated, enter the desired number 1-7 (Monday = 1). An "X" will appear under that day, indicating the previously entered schedule for that day is active. Entering a day's number again will deactivate that day. Pressing 0 will turn all days on/off.

The temporary schedule will only be in effect for the days which have the letter x underneath them. As the week progresses, the days are reset to the deactive state.

When completed, press * to exit the temporary schedule entry mode.

PROGRAMMING DEVICE TIMERS

General Information

Device timers consist of an ON time & an OFF time, and selected days of the week in which they are active. There are up to 20 timers that can be used to control various devices, such as lights or appliances. Your installer will have programmed the appropriate devices into the system (up to 16 devices can be programmed).

Each timer controls a single device (designated as an output number) that you select. For example, timer 1 might be set to turn the porch lights on at 7:00pm and turn them off at 11:00pm. Timer 2 might turn on the air conditioner Monday-Friday at 4:30pm to cool the premises before you arrive at 5:00pm, and turn it off at 10:00pm when you are retiring for the night. If desired, different timers can control the same device. For example, timer 2 could be used Monday-Friday as in the previous example, and timer 3 could be set to turn the air conditioner on and off at different times Saturday and Sunday.

To enter the device timer menu mode:

Enter your security code, then press the **#** key followed by 83.

```
OUTPUT TIMER # ?  
01-20,00=QUIT 01
```

Up to 20 timers can be programmed. Each timer is identified by a number 1-20. Enter the desired timer number to be programmed (1-20). Press * to accept entry.

```
06 07:00P 11:45P  
PORCH LITE 04
```

If that timer number has already been programmed, a summary screen will appear. In this example:

06 = Timer #
04 = Output Device # affected by this timer
PORCH LITE = Output Descriptor for Device 4
07:00PM = Start Time;
11:45PM = Stop Time

Press * to continue.

See your installer for device numbers.

```
00 ENTER  
OUTPUT#  
00
```

Enter the desired output device number (1-16). As the number is entered, the device's description will appear.

To delete a previously programmed timer, enter 00 as the output number.

PROGRAMMING DEVICE TIMERS (cont'd)

00 ON TIME ?
00:00 PM

Enter the time you want the device turned on using 00:01 - 11:59 format. When the display shows the desired time, press the * key to move to the AM/PM field. Press any key 0-9 to change the AM/PM indication.

Enter 00:00 if this timer is not being used to turn something ON for the days selected below. (ex. using one timer to turn lights on one day and using another timer to turn them off on another day).

00 OFF TIME ?
00:00 PM

Enter the time you want the device turned off using 00:01 - 11:59 format. When the display shows the desired time, press the * key to move to the AM/PM field. Press any key 0-9 to change the AM/PM indication.

Enter 00:00 if this timer is not being used to turn something OFF for the days selected below. (ex. using one timer to turn lights on one day and using another timer to turn them off on another day).

00 DAYS?
MTWTFSS
HIT 0-7 X X

Select the days on which the device is to be activated by entering 1-7 (Monday = 1). An "X" will appear under that day, indicating the output for that day is active. Entering a day's number again will deactivate that day. Pressing 0 will turn all days on/off. The outputs will only be in effect for the days which have the letter x underneath them. As the week progresses, the selected days are reset to the inactive state, unless the permanent option is selected (next screen prompt). When completed, press * to continue.

00 PERMANENT ?
0 = NO, 1 = YES 0

Answering 1 (yes) means the system will continue executing this timer on a continuous basis. An answer of 0 means execute each day's output only once.

TESTING THE BURGLARY SYSTEM

(TO BE CONDUCTED WEEKLY)

5 Using the TEST Key

The **TEST** key puts your system into the Walk Test mode, which allows each protection point to be checked for proper operation.

1. Disarm the system and close all protected windows, doors, etc. **READY** should be displayed.
2. Enter your security code and press the ^{TEST} 5 key.
3. The external sounder should sound for 3 seconds and then turn off. If the sounder does not sound, it may be due to dialer communication activity. Wait a few minutes and try again. If the sounder still does not sound, **CALL FOR SERVICE IMMEDIATELY**.
4. The keypad will sound a single beep every 15 seconds as a reminder that the system is in Test mode.

Note that no alarm reports will be sent to the central monitoring station while the system is in Test mode.

5. Open and close each protected door and window in turn and listen for three beeps. The identification of each faulted protection point should appear on the display.
6. Walk in front of any interior motion detectors (if used) and listen for three beeps as movement is detected. The identification of the detector should appear on the display when it is activated. If a problem is experienced with any protection point (no confirming sounds, no display), **CALL FOR SERVICE IMMEDIATELY**.
7. Turn off Test mode by entering the security code and pressing the **OFF** key.

FIRE ALARM SYSTEM

General Your fire alarm system (if installed) is on 24 hours a day, providing continuous protection. In the event of an emergency, the installed smoke and heat detectors will automatically send signals to your Control/Communicator, triggering a loud, interrupted sound from the Keypad. An interrupted sound will also be produced by optional exterior sounders. A FIRE message will appear at your Keypad and remain on until you silence the alarm.

In Case Of Fire Alarm

1. Should you become aware of a fire emergency before your detectors sense the problem, go to your nearest Keypad and manually initiate an alarm by pressing the panic key pair assigned as FIRE emergency (if programmed by the installer) and hold down for at least 2 seconds.
2. Evacuate all occupants from the premises.
3. If flames and/or smoke are present, leave the premises and notify your local Fire Department immediately.
4. If no flames or smoke are apparent, investigate the cause of the alarm. The zone descriptor of the zone(s) in an alarm condition will appear at the Keypad.

Silencing A Fire Alarm

1. Silence the alarm by entering your code and pressing the **OFF** key. To clear the display, enter your code and press the **OFF** key again.
2. If the Keypad does not indicate a **READY** condition after the second **OFF** sequence, press the **READY** key to display the zone(s) that are faulted. Be sure to check that smoke detectors are not responding to smoke or heat producing objects in their vicinity. Should this be the case, eliminate the source of heat or smoke.
3. If this does not remedy the problem, there may still be smoke in the detector. Clear it by fanning the detector for about 30 seconds.
4. When the problem has been corrected, clear the display by entering your code and pressing the **OFF** key.

TESTING THE FIRE SYSTEM

Fire Drill Test (code + [#] + 69)

This test causes fire bells to be activated (in either steady or pulsing manner as programmed in the system) for the purpose of conducting a fire drill or a bell test. This test can only be activated by the installer or a master user as follows:

1. Enter the corresponding security code and press [#] + 69 (make sure the burglary portion of the system is disarmed). Consoles will display "FIRE DRILL ACTIVE" while this test is active.
2. The test may be stopped by entering any security code and pressing OFF.

Note that the system continues to monitor all 24 hour zones (fire, panic, etc.) while this test is active, and will end the test when an alarm condition is detected. This test should be conducted at periodic intervals as determined by the local authority having jurisdiction.

TROUBLE CONDITIONS

Typical Trouble Displays

The word **CHECK** or **TRBL** on the Keypad's display, accompanied by a rapid "beeping" at the Keypad, indicates that there is a trouble condition in the system.

To silence the beeping sound for "check" conditions, press any key.

1. A display of "**CHECK**" or "**TRBL**" accompanied by a display of "**CALL SERVICE**" indicates that a problem exists with the system that eliminates some of the protection. **CALL FOR SERVICE IMMEDIATELY.**
2. A display of "**CHECK**" or "**TRBL**" accompanied by a display of one or more zone descriptors indicates that a problem exists with those zone(s)*. First, determine if the zone(s) displayed are intact and make them so if they are not. If the problem has been corrected, key an OFF sequence (Security Code plus OFF) to clear the display. If the display persists, **CALL FOR SERVICE IMMEDIATELY.**
3. A display of "**CHECK**" or "**TRBL**" accompanied by a numeric display of "6XX," where XX = 01-16, indicates a trouble on a supervised relay (corresponding relay number 01-16)
4. A display of "**CHECK**" or "**TRBL**" accompanied by a numeric display of "8XX," where XX = 00-31, indicates a trouble on a peripheral device (connected to the panel's keypad terminals) of the corresponding device address (00-31)
5. A display of "**CHECK**" or "**TRBL**" accompanied by a numeric display of "9XX," where XX = 00-99, indicates that a system trouble exists (dialers, bell outputs, ground fault, etc). These zones are as follows:

970: Bell 1 Output	975: Dialer 2
971: Bell 2 Output	987: Voice Module
972: Earth Ground Fault	988: 2nd RF Receiver - not receiving signals
973: J2 Trigger Output	990: 1st RF Receiver - not receiving signals
974: Dialer 1	

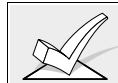

If the problem has been corrected, enter the [Security Code] plus [OFF] twice to clear the display.

TROUBLE CONDITIONS (cont'd)

6. A display of "**COMM. FAILURE**" at the Keypad indicates that a failure has occurred in the telephone communication portion of your system. CALL FOR SERVICE IMMEDIATELY.
7. A display of "**SYSTEM LO BAT**" per minute "beeping" at the Keypad indicates that a low system battery condition exists. CALL FOR SERVICE IMMEDIATELY.
8. A display of "**LO BAT**" and a zone descriptor, accompanied by a once per minute "beeping" at the Keypad indicates that a low battery condition exists in the wireless transmitter** displayed. CALL FOR SERVICE IMMEDIATELY.
9. A display of "**MODEM COMM**" indicates that the control is on-line with the central station's remote computer. The control will not operate while on-line.

Power Failure

If the **POWER** indicator is off, operating power for the system has stopped and is inoperative. CALL FOR SERVICE IMMEDIATELY. If the **POWER** indicator is on, but the message "**AC LOSS**" is displayed, the Keypad is operating on battery power only. If only some lights are out on the premises, check circuit breakers and fuses and reset or replace as necessary. CALL FOR SERVICE IMMEDIATELY if AC power cannot be restored.

SERVICING INFORMATION

Your local Ademco dealer is the person best qualified to service your alarm system. Arranging some kind of regular service program with him is advisable.

Your local Ademco dealer is:

Name: _____

Address: _____

Phone: _____

RECOMMENDATIONS FOR PROPER PROTECTION

THE FOLLOWING RECOMMENDATIONS FOR THE LOCATION OF FIRE AND BURGLARY DETECTION DEVICES HELP PROVIDE PROPER COVERAGE FOR THE PROTECTED PREMISES.

RECOMMENDATIONS FOR SMOKE AND HEAT DETECTORS

With regard to the number and placement of smoke/heat detectors, we subscribe to the recommendations contained in the National Fire Protection Association's (NFPA) Standard #72 noted below.

Early warning fire detection is best achieved by the installation of fire detection equipment in all rooms and areas of the household as follows: For minimum protection a smoke detector should be installed outside of each separate sleeping area, and on each additional floor of a multi-floor family living unit, including basements. The installation of smoke detectors in kitchens, attics (finished or unfinished), or in garages is not normally recommended.

For additional protection the NFPA recommends that you install heat or smoke detectors in the living room, dining room, bedroom(s), kitchen, hallway(s), attic, furnace room, utility and storage rooms, basements and attached garages.

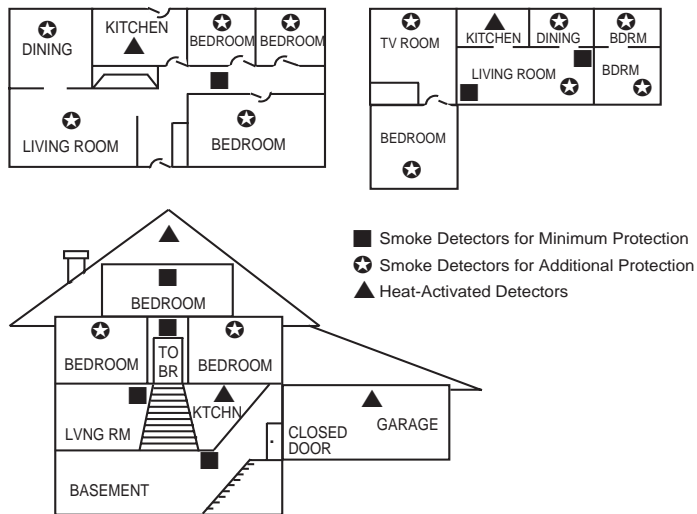

RECOMMENDATIONS FOR PROPER PROTECTION (cont.)

In addition, we recommend the following:

- Install a smoke detector inside every bedroom where a smoker sleeps.
- Install a smoke detector inside every bedroom where someone sleeps with the door partly or completely closed. Smoke could be blocked by the closed door. Also, an alarm in the hallway outside may not wake up the sleeper if the door is closed.
- Install a smoke detector inside bedrooms where electrical appliances (such as portable heaters, air conditioners or humidifiers) are used.
- Install a smoke detector at both ends of a hallway if the hallway is more than 40 feet (12 meters) long.
- Install smoke detectors in any room where an alarm control is located, or in any room where alarm control connections to an AC source or phone lines are made. If detectors are not so located, a fire within the room could prevent the control from reporting a fire or an intrusion.

RECOMMENDATIONS FOR PROPER INTRUSION PROTECTION

For proper intrusion coverage, sensors should be located at every possible point of entry to a home or commercial premises. This would include any skylights that may be present, and the upper windows in a multi-level building.

In addition, we recommend that radio backup be used in a security system so that alarm signals can still be sent to the alarm monitoring station in the event that the telephone lines are out of order (alarm signals are normally sent over the phone lines, if connected to an alarm monitoring station).

EMERGENCY EVACUATION

Establish and regularly practice a plan of escape in the event of fire. The following steps are recommended by the National Fire Protection Association:

1. Position your detector or your interior and/or exterior sounders so that they can be heard by all occupants.
2. Determine two means of escape from each room. One path of escape should lead to the door that permits normal exit from the building. The other may be a window, should your path be impassable. Station an escape ladder at such windows if there is a long drop to the ground.
3. Sketch a floor plan of the building. Show windows, doors, stairs and rooftops that can be used to escape. Indicate escape routes for each room. Keep these routes free from obstruction and post copies of the escape routes in every room.
4. Assure that all bedroom doors are shut while you are asleep. This will prevent deadly smoke from entering while you escape.
5. Try the door. If the door is hot, check your alternate escape route. If the door is cool, open it cautiously. Be prepared to slam the door if smoke or heat rushes in.
6. Where smoke is present, crawl on the ground; do not walk upright. Smoke rises and may overcome you. Clearer air is near the floor.
7. Escape quickly; don't panic.
8. Establish a common meeting place outdoors, away from your house, where everyone can meet and then take steps to contact the authorities and account for those missing. Choose someone to assure that nobody returns to the house — many die going back.

MAINTAINING YOUR SYSTEM

Taking Care of Your System

The components of your security system are designed to be as free of maintenance as possible. However, there are some things you can do to make sure that your system is in reliable working condition.

1. Test your system weekly.
2. Test the system after any alarm occurs (see *TESTING THE SYSTEM*).

Replacing Batteries in Wireless Sensors

Wireless sensors may not have been used in your security system

Each wireless sensor in your system has a 9-volt or 3-volt battery. The system detects a low battery in any wireless sensor, including smoke detectors, the optional personal emergency transmitter, and the optional portable wireless keypad. (A low battery in a portable wireless keypad is detected as soon as one of its keys is pressed, and the keypad will display **00**.)

Alkaline batteries provide a minimum of 1 year of operation, and in most units and applications, provide 2–4 years of service. Actual battery life will depend on the environment in which the sensor is used, the number of signals that the transmitter in the sensor has had to send, and the specific type of sensor. Factors such as humidity, high or low temperatures or large swings in temperature, may all lead to the reduction of actual battery life in an installation.

If you have a low battery in a wireless sensor, a low battery message is displayed on the keypad.

In addition, a battery-operated smoke detector with a low battery also emits a single "chirp" sound once approximately every 20-30 seconds, identifying itself as the smoke detector with the weak battery. If you do not replace a smoke detector's low battery, the smoke detector may sound continuously, as if there were a fire alarm.

Note: The low battery message comes on as a warning that battery replacement in indicated sensor(s) is due within 30 days. In the meantime, the sensor(s) causing the low battery indication is still fully operational.

Important: Use only batteries recommended by your installer as replacement.

MAINTAINING YOUR SYSTEM (cont'd)

Silencing Low Battery Warning Tones at the Keypad

The keypad's warning tones can be silenced by performing an OFF sequence (code plus OFF key), but the Keypad's low battery message display will remain on as a reminder that you have a low battery condition in one or more of your sensors. When you replace the weak battery with a fresh one, the sensor will send a "good battery" signal to the control as soon as the sensor is activated (opening/closing of door, window, etc.), causing the low battery display to turn off. If the sensor is not activated, the display will automatically clear within approximately 1 hour.

- Routine Care**
- Treat the components of your security system as you would any other electrical equipment. Do not slam sensor-protected doors or windows.
 - Keep dust from accumulating on the keypad and all protective sensors, particularly on motion sensors and smoke detectors.
 - The keypad and sensors should be cleaned carefully with a dry soft cloth. ***Do not spray water or any other fluid on the units.***

QUICK GUIDE TO SYSTEM FUNCTIONS

FUNCTION	PROCEDURE	COMMENTS
Check Zones	Press [★]	To view faulted zones when system not ready.
Display All Descriptors	Press and hold [★] for 5 seconds	Displays all alpha descriptors programmed by installer.
Arm System	Enter code Press arming key desired (AWAY, STAY, INSTANT, MAXIMUM)	Arms system in mode selected.
Disarm System	Enter code Press OFF [1]	Disarms system and silences alarms.
Bypass zones	Enter code Press BYPASS [6] Enter zone numbers to be bypassed (use 2-digit entries)	Bypassed zones are unprotected and will not cause an alarm if violated.
Quick Bypass	Enter code Press BYPASS [6] Press [#]	Bypasses all faulted zones automatically.
Chime Mode	Enter code Press CHIME [9]	Keypad will sound if doors or windows are violated while system disarmed.
Test Mode	Enter code	Sounds alarm sounder and allows sensors to be tested. Press TEST [5]
View Messages	Press and hold [0] for at least 5 seconds.	Message from central station will appear.
View User Capabilities	Enter user's code Press [★] + [★]	Displays partitions & authority levels assigned to the user.

QUICK GUIDE TO SYSTEM FUNCTIONS

FUNCTION	PROCEDURE	COMMENTS
GOTO Partition	Enter security code Press [★] Enter partition number (1-8) 0 returns to default partition	Allows a user at one keypad to perform functions in another partition, if that user is authorized to do so.
Add a User	Enter master/manager code Press CODE [8] Enter new user's user number Enter code for that user At prompt, enter authority for that user in this partition (1-5) Follow prompts, 1=Yes, 0=No	Master & Manager level users can add users to the system, each with its own code and authority level.
Change a user's Code	Enter master/manager code Press CODE [8] Enter user's 2-digit number Enter new code for that user Press 0 (No) at prompt.	Master & Manager level users can change their own or other users' codes.
Delete a User	Enter master/manager code Press CODE [8] Enter user no. to be deleted Enter master/manager code Press 1 (Yes) at prompt.	Master & Manager level users can delete users. A user can only be deleted by a user with higher authority level.
Self-Help	Press and hold any function key for at least 5 seconds.	Will display abbreviated instructions for the key pressed.

SUMMARY OF AUDIBLE NOTIFICATION

(ALPHA DISPLAY KEYPADS)

SOUND	CAUSE	DISPLAY
LOUD, INTERRUPTED* Keypad & External	FIRE ALARM	FIRE is displayed; descriptor of zone in alarm is displayed.
LOUD, CONTINUOUS* Keypad & External	BURGLARY/AUDIBLE EMERGENCY ALARM	ALARM is displayed; descriptor of zone in alarm is also displayed.
ONE SHORT BEEP (not repeated) Keypad only	a. SYSTEM DISARM b. SYSTEM ARMING ATTEMPT WITH AN OPEN ZONE. c. BYPASS VERIFY	a. DISARMED/READY TO ARM is displayed. b. The number and descriptor of the open protection zone is displayed. c. Numbers and descriptors of the bypassed protection zones are displayed (One beep is heard for each zone displayed). Subsequently, the following is displayed: DISARMED BYPASS Ready to Arm
ONE SHORT BEEP (once every 15 seconds) Keypad only	SYSTEM IS IN TEST MODE	Opened Zone identifications will appear.
ONE BEEP every 60 sec. Keypad only	LOW BATTERY AT A TRANSMITTER	LO BAT displayed with description of transmitter.
TWO SHORT BEEPS Keypad only	ARM AWAY OR MAXIMUM	ARMED AWAY or ARMED MAXIMUM is displayed. Red ARMED indicator is lit.
THREE SHORT BEEPS Keypad only	a. ARM STAY OR INSTANT b. ZONE OPENED WHILE SYSTEM IS IN CHIME MODE. c. ENTRY WARNING**	a. ARMED STAY ZONE BYPASSED or ARMED INSTANT ZONE BYPASSED is displayed. Red ARMED indicator is lit. b. CHIME displayed, descriptor of open protection zone will be displayed if the [*] key is pressed. c. DISARM SYSTEM OR ALARM WILL OCCUR is displayed.
RAPID BEEPING Keypad only	a. TROUBLE b. AC POWER LOSS ALERT*** c. MEMORY OF ALARM	a. CHECK displayed. Descriptor of troubled protection zone is displayed. b. AC LOSS displayed (may alternate with other displays that may be present). c. FIRE or ALARM is displayed; descriptor of zone in alarm is displayed.
SLOW BEEPING Keypad only	a. ENTRY DELAY WARNING** b. EXIT DELAY WARNING (if programmed)	a. DISARM SYSTEM OR ALARM WILL OCCUR is displayed. Exceeding the delay time without disarming causes alarm. b. ARMED AWAY or ARMED MAXIMUM is displayed along with You May Exit Now

- * If bell is used as external sounder, fire alarm is pulsed ring; burglary/audible emergency is steady ring.
- ** Entry warning may consist of three short beeps or slow continuous beeping, as programmed by your installer.
- *** Loss of system battery power is not indicated or annunciated by the keypad (warnings are for loss of AC power only).

GLOSSARY

The following terms are used throughout the manual.

- ARM/DISARM:** "Armed" simply means that the burglary portion of your system is turned ON and is in a state of readiness. "Disarmed" means that the burglary system is turned OFF, and must be rearmed to become operational. However, even in a "disarmed" state, "emergency" and "fire" portions of your system are still operational.
- KEYPAD:** This is the area on your Keypad containing numbered pushbuttons similar to those on telephones or calculators. These keys control the arming or disarming of the system, and perform other functions which were previously described in this manual.
- ZONE:** A specific area of protection.
- PARTITION:** An independent group of zones that can be armed and disarmed without affecting other zones or users.
- BYPASS:** To disarm a specific area of burglary protection while leaving other areas operational.
- DELAY ZONE:** An area of protection containing doors most frequently used to enter or exit (typically, a front door, back door, or door from the garage into the building). The delay zone allows sufficient time for authorized entry or exit without causing an alarm. Consult your installer for the entry and exit delay times that have been set for your system during installation and record them on the separate sheet provided in this manual.
- DAY/NIGHT ZONE:** An area of protection whose violation causes a trouble indication during the disarmed (DAY) mode and an alarm during the armed (NIGHT) mode.

UL NOTICE: This is a "GRADE A" system.

"FEDERAL COMMUNICATIONS COMMISSION (FCC) Part 15 STATEMENT"

This equipment has been tested to FCC requirements and has been found acceptable for use. The FCC requires the following statement for your information:

This equipment generates and uses radio frequency energy and if not installed and used properly, that is, in strict accordance with the manufacturer's instructions, may cause interference to radio and television reception. It has been type tested and found to comply with the limits for a Class B computing device in accordance with the specifications in Part 15 of FCC Rules, which are designed to provide reasonable protection against such interference in a residential installation. However, there is no guarantee that interference will not occur in a particular installation. If this equipment does cause interference to radio or television reception, which can be determined by turning the equipment off and on, the user is encouraged to try to correct the interference by one or more of the following measures:

- If using an indoor antenna, have a quality outdoor antenna installed.
- Reorient the receiving antenna until interference is reduced or eliminated.
- Move the receiver away from the control/communicator.
- Move the antenna leads away from any wire runs to the control/communicator.
- Plug the control/communicator into a different outlet so that it and the receiver are on different branch circuits.

If necessary, the user should consult the dealer or an experienced radio/television technician for additional suggestions.

The user or installer may find the following booklet prepared by the Federal Communications Commission helpful: "Interference Handbook"

This booklet is available from the U.S. Government Printing Office, Washington, DC 20402.

The user shall not make any changes or modifications to the equipment unless authorized by the Installation Instructions or User's Manual. Unauthorized changes or modifications could void the user's authority to operate the equipment.

IN THE EVENT OF TELEPHONE OPERATIONAL PROBLEMS

In the event of telephone operational problems, disconnect the control by removing the plug from the RJ31X (CA38A in Canada) telephone wall jack. We recommend that your certified installer demonstrate disconnecting the phones on installation of the system. Do not disconnect the phone connection inside the control/communicator. Doing so will result in the loss of your phone lines. If the regular phone works correctly after the control/communicator has been disconnected from the phone lines, the control/communicator has a problem and should be returned for repair. If upon disconnection of the control/communicator, there is still a problem on the line, notify the telephone company that they have a problem and request prompt repair service. The user may not under any circumstances (in or out of warranty) attempt any service or repairs to the system. It must be returned to the factory or an authorized service agency for all repairs.

"FEDERAL COMMUNICATIONS COMMISSION (FCC) Part 68 NOTICE

This equipment complies with Part 68 of the FCC rules. On the front cover of this equipment is a label that contains, among other information, the FCC registration number and ringer equivalence number (REN) for this equipment. If requested, this information must be provided to the telephone company.

This equipment uses the following jacks:

An RJ31X is used to connect this equipment to the telephone network.

The REN is used to determine the quantity of devices which may be connected to the telephone line. Excessive RENs on the telephone line may result in the devices not ringing in response to an incoming call. In most, but not all areas, the sum of the RENs should not exceed five (5.0). To be certain of the number of devices that may be connected to the line, as determined by the total RENs, contact the telephone company to determine the maximum REN for the calling area.

If this equipment causes harm to the telephone network, the telephone company will notify you in advance that temporary discontinuance of service may be required. If advance notice is not practical, the telephone company will notify the customer as soon as possible. Also, you will be advised of your right to file a complaint with the FCC if you believe necessary.

The telephone company may make changes in its facilities, equipment, operations, or procedures that could affect the operation of the equipment. If this happens, the telephone company will provide advance notice in order for you to make the necessary modifications in order to maintain uninterrupted service.

If trouble is experienced with this equipment, please contact the manufacturer for repair and warranty information. If the trouble is causing harm to the telephone network, the telephone company may request you remove the equipment from the network until the problem is resolved.

There are no user serviceable components in this product, and all necessary repairs must be made by the manufacturer. Other repair methods may invalidate the FCC registration on this product.

This equipment cannot be used on telephone company-provided coin service. Connection to Party Line Service is subject to state tariffs.

This equipment is hearing-aid compatible.

When programming or making test calls to an emergency number, briefly explain to the dispatcher the reason for the call. Perform such activities in the off-peak hours; such as early morning or late evening.

**CANADIAN DEPARTMENT OF COMMUNICATIONS
(DOC) STATEMENT**

NOTICE

The Canadian Department of Communications label identifies certified equipment. This certification means that the equipment meets certain telecommunications network protective, operational and safety requirements. The Department does not guarantee the equipment will operate to the user's satisfaction.

Before installing this equipment, users should ensure that it is permissible to be connected to the facilities of the local telecommunications company. The equipment must also be installed using an acceptable method of connection. In some cases, the company's inside wiring associated with a single line individual service may be extended by means of certified connector assembly (telephone extension cord). The customer should be aware that compliance with the above conditions may not prevent degradation of service in some situations.

Repairs to certified equipment should be made by an authorized Canadian maintenance facility designated by the supplier. Any repairs or alterations made by the user to this equipment, or equipment malfunctions, may give the telecommunications company cause to request the user to disconnect the equipment.

Users should ensure for their own protection that the electrical ground connections of the power utility, telephone lines and internal metallic water pipe system, if present, are connected together. This precaution may be particularly important in rural areas.

Caution: User should not attempt to make such connections themselves, but should contact the appropriate electric inspection authority, or electrician, as appropriate.

The Load Number (LN) assigned to each terminal device denotes the percentage of the total load to be connected to a telephone loop which is used by the device, to prevent overloading. The termination on a loop may consist of any combination of devices subject only to the requirement that the total of the Load Numbers of all the devices does not exceed 100.

AVIS

L'étiquette du ministère des Communications du Canada identifie le matériel homologué. Cette étiquette certifie que le matériel est conforme à certaines normes de protection, d'exploitation et de sécurité des réseaux de télécommunications. Le ministère n'assure toutefois pas que le matériel fonctionnera à la satisfaction de l'utilisateur.

Avant d'installer ce matériel, l'utilisateur doit s'assurer qu'il est permis de le raccorder aux installations de l'entreprise locale de télécommunications. Le matériel doit également être installé en suivant une méthode acceptée de raccordement. Dans certains cas, les fils intérieurs de l'entreprise utilisés pour un service individuel à la ligne unique peuvent être prolongés au moyen d'un dispositif homologué de raccordement (cordon prolongateur téléphonique interne). L'abonné ne doit pas oublier qu'il est possible que la conformité aux conditions énoncées ci-dessus n'empêche pas la dégradation du service dans certaines situations. Actuellement, les entreprises de télécommunications ne permettent pas que l'on raccorde leur matériel aux prises d'abonnés, sauf dans les cas précis prévus par les tarifs particuliers de ces entreprises.

Les réparations du matériel homologué doivent être effectuées par un centre d'entretien canadien autorisé désigné par le fournisseur. La compagnie de télécommunications peut demander à l'utilisateur de débrancher un appareil à la suite de réparations ou de modifications effectuées par l'utilisateur ou à cause de mauvais fonctionnement.

Pour sa propre protection, l'utilisateur doit s'assurer que tous les fils de mise en terre de la source d'énergie électrique, des lignes téléphoniques de réseau de conduites d'eau s'il y en a, soient raccordés ensemble. Cette précaution est particulièrement importante dans les régions rurales.

Avertissement: L'utilisateur ne doit pas tenter de faire ces raccordements lui-même; il doit avoir recours à un service d'inspection des installations électriques, ou à un électricien, selon le cas.

L'indice de charge (IC) assigné à chaque dispositif terminal pour éviter toute surcharge indique le pourcentage de la charge totale qui peut être raccordé à un circuit téléphonique bouclé utilisé par ce dispositif. La terminaison du circuit bouclé peut être constituée de n'importe quelle combinaison de dispositifs, pourvu que la somme des indices de charge de l'ensemble des dispositifs ne dépasse pas 100.

WARNING!
THE LIMITATIONS OF THIS ALARM SYSTEM

While this system is an advanced design security system, it does not offer guaranteed protection against burglary or fire or other emergency. Any alarm system, whether commercial or residential, is subject to compromise or failure to warn for a variety of reasons. For example:

- Intruders may gain access through unprotected openings or have the technical sophistication to bypass an alarm sensor or disconnect an alarm warning device.
- Intrusion detectors (e.g. passive infrared detectors), smoke detectors, and many other sensing devices will not work without power. Battery operated devices will not work without batteries, with dead batteries, or if the batteries are not put in properly. Devices powered solely by AC will not work if their AC power supply is cut off for any reason, however briefly.
- Signals sent by wireless transmitters may be blocked or reflected by metal before they reach the alarm receiver. Even if the signal path has been recently checked during a weekly test, blockage can occur if a metal object is moved into the path.
- A user may not be able to reach a panic or emergency button quickly enough.
- While smoke detectors have played a key role in reducing residential fire deaths in the United States, they may not activate or provide early warning for a variety of reasons in as many as 35% of all fires, according to data published by the Federal Emergency Management Agency. Some of the reasons smoke detectors used in conjunction with this System may not work are as follows. Smoke detectors may have been improperly installed and positioned. Smoke detectors may not sense fires that start where smoke cannot reach the detectors, such as in chimneys, in walls, or roofs, or on the other side of closed doors. Smoke detectors also may not sense a fire on another level of a residence or building. A second floor detector, for example, may not sense a first floor or basement fire. Moreover, smoke detectors have sensing limitations. No smoke detector can sense every kind of fire every time. In general, detectors may not always warn about fires caused by carelessness and safety hazards like smoking in bed, violent explosions, escaping gas, improper storage of flammable materials, overloaded electrical circuits, children playing with matches, or arson. Depending upon the nature of the fire and/or the locations of the smoke detectors, the detector, even if it operates as anticipated, may not provide sufficient warning to allow all occupants to escape in time to prevent injury or death.
- Passive Infrared Motion Detectors can only detect intrusion within the designed ranges as diagrammed in their installation manual. Passive Infrared Detectors do not provide volumetric area protection. They do create multiple beams of protection, and intrusion can only be detected in unobstructed areas covered by those beams. They cannot detect motion or intrusion that takes place behind walls, ceilings, floors, closed doors, glass partitions, glass doors, or windows. Mechanical tampering, masking, painting or spraying of any material on the mirrors, windows or any part of the optical system can reduce their detection ability. Passive Infrared Detectors sense changes in temperature; however, as the ambient temperature of protected area approaches the temperature range of 90° to 105°F, the detection performance can decrease.

WARNING!
THE LIMITATIONS OF THIS ALARM SYSTEM
(continued)

- Alarm warning devices such as sirens, bells or horns may not alert people or wake up sleepers if they are located on the other side of closed or partly open doors. If warning devices sound on a different level of the residence from the bedrooms, then they are less likely to waken or alert people inside the bedrooms. Even persons who are awake may not hear the warning if the alarm is muffled from a stereo, radio, air conditioner or other appliance, or by passing traffic. Finally, alarm warning devices, however loud, may not warn hearing-impaired people or waken deep sleepers.
- Telephone lines needed to transmit alarm signals from a premises to a central monitoring station may be out of service or temporarily out of service. Telephone lines are also subject to compromise by sophisticated intruders.
- Even if the system responds to the emergency as intended, however, occupants may have insufficient time to protect themselves from the emergency situation. In the case of a monitored alarm system, authorities may not respond appropriately.
- This equipment, like other electrical devices, is subject to component failure. Even though this equipment is designed to last as long as 10 years, the electronic components could fail at any time.

The most common cause of an alarm system not functioning when an intrusion or fire occurs is inadequate maintenance. This alarm system should be tested weekly to make sure all sensors and transmitters are working properly.

Installing an alarm system may make one eligible for lower insurance rates, but an alarm system is not a substitute for insurance. Homeowners, property owners and renters should continue to act prudently in protecting themselves and continue to insure their lives and property.

We continue to develop new and improved protection devices. Users of alarm systems owe it to themselves and their loved ones to learn about these developments.

INDEX

97= Call Service	45	Instant	4, 10, 18, 25
AC	10	Keypads	7
AC Loss	45	Keyswitch	29
Access Another Partition	18	Lo Bat	44
Access Door	34	Low Battery	50
Add A User	15	Low Battery Warning	51
Ademco Dealer	45	Maintenance	50
Alarm	4, 10	Manager	13
Alpha	7	Master	13
Alpha Keypads	7	Maximum	4, 18, 27
Armed	4	Memory Of Alarm	4, 28
Audible Emergency	32	Modem Comm	44
Authority Level	12	No AC	10, 45
Authority Levels	3, 14	Not Ready	10, 20
Away	4, 10, 18, 26, 29	Off	18, 28, 46
Bat	10, 45	Open Zones	20
Burglary	3	Open/Close Schedules	37
Burglary Protection	4	Operator A	13
Bypass	10	Operator B	13
Bypass Zones	22	Operator C	13
Bypassing	22	Panic Keys	32
Call Service	44	Partitioned Security System	3
CC	45	Partitioned System	3
Change A User's Code	17	Personal Emergency	32
Check	10, 44	Power	45
Chime	4, 10, 30	Quick Arming	12
Closing Time	36	Quick Bypass	23
Code	15	Ready	10, 20, 30, 46
Comm. Failure	44	Ready Key	20, 21
Delaying The Closing Time.....	36	Replacing Batteries	50
Delete A User	17	Schedules	5, 36
Descriptors	21	Security Code	12
Device Timers	5, 40	Security Codes	12
Disarm	28	Sensing Devices	3
Duress	13	Silence The Alarm	46
Duress Code	12	Silent Emergency	32
Emergency	3	Smoke Detectors	43
Entry Delay	11	Stay	4, 10, 18, 24, 29
Entry/Exit	3	System Lo Bat	44
Exit Delay	11	Temporary Schedules	37, 38
Exit User Edit Mode	14	Temporary Users	15
FC	45	Test Key	42
Fire	3, 10, 32, 46	Time Window	37
Fire Emergency	46	Trouble Condition	44
Fire Protection	4	User Edit Mode	14
Fixed-Word	7	User Numbers	12
Fixed-Word Keypad Displays	10	User's Instructions	6
Fixed-Word Keypads	7	4285 VIP Module	6, 35
Global Arming	18	Wireless Sensor	50
Goto	16, 18	Zone Bypassed	24
Goto Command	5	Zone Descriptors	21

ADEMCO ONE YEAR LIMITED WARRANTY

Alarm Device Manufacturing Company, a Division of Pittway Corporation, and its divisions, subsidiaries and affiliates ("Seller"), 165 Eileen Way, Syosset, New York 11791, warrants its security equipment (the "product") to be free from defects in materials and workmanship for one year from date of original purchase, under normal use and service. Seller's obligation is limited to repairing or replacing, at its option, free of charge for parts, labor, or transportation, any product proven to be defective in materials or workmanship under normal use and service. Seller shall have no obligation under this warranty or otherwise if the product is altered or improperly repaired or serviced by anyone other than the Seller. In case of defect, contact the security professional who installed and maintains your security equipment or the Seller for product repair.

This one year Limited Warranty is in lieu of all other express warranties, obligations or liabilities. THERE ARE NO EXPRESS WARRANTIES, WHICH EXTEND BEYOND THE FACE HEREOF. ANY IMPLIED WARRANTIES, OBLIGATIONS OR LIABILITIES MADE BY SELLER IN CONNECTION WITH THIS PRODUCT, INCLUDING ANY IMPLIED WARRANTY OF MERCHANTABILITY, OR FITNESS FOR A PARTICULAR PURPOSE OR OTHERWISE, ARE LIMITED IN DURATION TO A PERIOD OF ONE YEAR FROM THE DATE OF ORIGINAL PURCHASE. ANY ACTION FOR BREACH OF ANY WARRANTY, INCLUDING BUT NOT LIMITED TO ANY IMPLIED WARRANTY OF MERCHANTABILITY, MUST BE BROUGHT WITHIN 12 MONTHS FROM DATE OF ORIGINAL PURCHASE. IN NO CASE SHALL SELLER BE LIABLE TO ANYONE FOR ANY CONSEQUENTIAL OR INCIDENTAL DAMAGES FOR BREACH OF THIS OR ANY OTHER WARRANTY, EXPRESS OR IMPLIED, OR UPON ANY OTHER BASIS OF LIABILITY WHATSOEVER, EVEN IF THE LOSS OR DAMAGE IS CAUSED BY THE SELLER'S OWN NEGLIGENCE OR FAULT. Some states do not allow limitation on how long an implied warranty lasts or the exclusion or limitation of incidental or consequential damages, so the above limitation or exclusion may not apply to you.

Seller does not represent that the product may not be compromised or circumvented; that the product will prevent any personal injury or property loss by burglary, robbery, fire or otherwise; or that the product will in all cases provide adequate warning or protection. Buyer understands that a properly installed and maintained alarm may only reduce the risk of a burglary, robbery, fire or other events occurring without providing an alarm, but it is not insurance or a guarantee that such will not occur or that there will be no personal injury or property loss as a result. CONSEQUENTLY, SELLER SHALL HAVE NO LIABILITY FOR ANY PERSONAL INJURY, PROPERTY DAMAGE OR OTHER LOSS BASED ON A CLAIM THE PRODUCT FAILED TO GIVE WARNING. HOWEVER, IF SELLER IS HELD LIABLE, WHETHER DIRECTLY OR INDIRECTLY, FOR ANY LOSS OR DAMAGE ARISING UNDER THIS LIMITED WARRANTY OR OTHERWISE, REGARDLESS OF CAUSE OR ORIGIN, SELLER'S MAXIMUM LIABILITY SHALL NOT IN ANY CASE EXCEED THE PURCHASE PRICE OF THE PRODUCT, WHICH SHALL BE THE COMPLETE AND EXCLUSIVE REMEDY AGAINST SELLER. This warranty gives you specific legal rights, and you may also have other rights which vary from state to state. No increase or alteration, written or verbal, to this warranty is authorized.

ADEMCO
GROUP

A DIVISION OF PITTWAY CORPORATION
165 Eileen Way, Syosset, New York 11791
Copyright © 1995 PITTWAY CORPORATION



N6020-2 Rev B 4/99

EVENT LOGGING PROCEDURES

General Information

The system has the ability to record various events in a history log wherein each event is recorded in one of five categories (listed below), with the time and date of its occurrence. The Event Log holds up to 224 events, with the oldest event being replaced by the logging of any new event after the log is full. Using an alpha keypad, the Event Log can be viewed one category at a time, or can display all events, regardless of category (ALL EVENT LOG). The system also allows selection of displaying the COMPLETE log, or only those events occurring since the last installer service (RECENT). In addition, events in the other partitions can be viewed by users authorized to access those partitions. Note that events are displayed in chronological order, from most recent to oldest.

To Display The Event Log

1. **Enter CODE + [#] + [6] + [0]**
2. **Select the display mode.**
RECENT: Displays only those events occurring since last installer service.
COMPLETE: Displays complete event log (up to 224 events).
Press the desired key, 0 or 1.

ENTER 0 = RECENT 1 = COMPLETE

3. **Select the partition, 0-8.**
Enter the partition number for the partition whose events are to be displayed.
Entering 0 (NO) will display all partitions' events.

SCAN LOG BY PART 0=NO 1-8=PART #

EVENT LOGGING PROCEDURES (cont'd)

4. Use the [3] & [1] keys (for next and previous categories respectively) to display the categories of events.

Press [8] to select a category and display the first event. Press [8] again for each subsequent event.

Shows burglary alarm occurred in zone 3 (C03) of partition 1 (P1), at 12:02AM on January 1.

P1 01/01	12:02AM
BURGLARY	C03

*Typical Event
Log Display*

After the last event has been displayed, the END OF EVENT LOG message appears for a few seconds, then the system automatically displays the RECENT/COMPLETE mode select screen again (see step 2).

5. To EXIT the Event Log:
Press [*] at any time.

ALARM EVENT LOG
TYPE CCC UUU

*Typical Category
Select Screen*

ALARM EVENT LOG

Displays time and date for zones that have either caused an alarm or have been restored in the selected partition.

CHECK EVENT LOG

Displays time and date for zones that have caused a trouble or supervisory condition in the selected partition.

BYPASS EVENT LOG

Displays time and date for zones that have been bypassed in the partition.

OPEN EVENT LOG

Displays time, date and user number for each arming and disarming of the system for the partition selected.

SYSTEM EVENT LOG

Displays time and date for system problems, such as AC Loss, low battery, etc., regardless of partition.

ALL EVENT LOG

Displays all categories of events in chronological order.

See your Installer for additional information concerning the event log.
--